



EGLO  
my light | my style



Уличное освещение

2016/17





Дорогие клиенты, партнеры и верные друзья EGLO!

Время проведенное на природе бесценно. Мы предлагаем Вам совершенные решения в уличном освещении для Вашего сада, дачи или загородного дома, с расчетом на ваш личный комфорт. Ассортимент нашей коллекции уличных светильников разнообразен: технологичные и функциональные светильники с современным дизайном в различных стилях, от классики до модерна. Изучайте и выбирайте свой любимый светильник для создания необходимой атмосферы и персонального удобства.



Приятного просмотра нашего нового каталога Уличное освещение 2016/17!

Маг. Рене Тифенбахер  
Генеральный директор EGLO Group



	<b>Светильники с яркими особенностями</b> Светильники с датчиками движения & датчики движения	004 - 009
---	---	-----------

## Категории светильников

	Модерн	010 - 068
	Классика	069 - 117
	Встраиваемые светильники, споты & аксессуары	118 - 131

## Концепции

	Светильники для сада	132 - 137
---	----------------------	-----------

## Приложение

	Условные обозначения & Оглавление	138 - 144
---	-----------------------------------	-----------



› Экономия



› Удобство



› Меньше движений



› Безопасность

правильный  
**Свет**  
в нужное  
**время**

**Правильный свет - в нужное время**

Светильники, оснащенные датчиками движения и функцией, реагирующей на смену светлого времени суток на темное, дают массу преимуществ. Уберегают от незваных гостей, защищают вас и вашу семью от неожиданных падений с наступлением темноты, а в моменты, когда ваши руки заняты чем-либо, экономят время на включение света. Светильники с датчиками движения и датчики света обеспечивают комфорт Вашей повседневной жизни





правильный  
**Свет**  
в нужное  
время

## Модерн



**POLIENTO**  
стр. 14



**TRONO STICK**  
стр. 20



**HELSINKI**  
стр. 26



**HELSINKI**  
стр. 26



**HELSINKI**  
стр. 27



**NISIA**  
стр. 28



**ATOLLARI**  
стр. 34



**ATOLLARI**  
стр. 34



**SESIMBA 1**  
стр. 40



**SESIMBA 1**  
стр. 40



**SESIMBA 1**  
стр. 40



**BREGANZO 1**  
стр. 51



**BREGANZO 1**  
стр. 51



**CITY LED**  
стр. 54



**CITY 1**  
стр. 55



**CITY**  
стр. 55



**CITY**  
стр. 55



**CERNO**  
стр. 138



**CERNO**  
стр. 56



**RALORA 1**  
стр. 57



**TRABADA**  
стр. 58



**TRABADA**  
стр. 58



правильный  
**Свет**  
в нужное  
**время**

## Классика



**SIDNEY**  
стр. 96



**LISIO**  
стр. 101



**MOUNA**  
стр. 102



**NAVEDO**  
стр. 106



**NAVEDO**  
стр. 110



**LATERNA 5**  
стр. 113



**LATERNA 4**  
стр. 115

## Встраиваемые светильники, споты & аксессуары



**FAEDO 1**  
стр. 122



**FAEDO 1**  
стр. 122



**FAEDO 1**  
стр. 122



**FAEDO 1**  
стр. 123



**DETECT ME 1**  
стр. 128



**DETECT ME 1**  
стр. 128



**DETECT ME 2**  
стр. 128



**DETECT ME 2**  
стр. 128



**DETECT ME 3**  
стр. 128



**DETECT ME 3**  
стр. 128



**DETECT ME 4**  
стр. 129



**DETECT ME 4**  
стр. 129



Модерн



 <b>POLIENTO</b> стр. 14	 <b>PENALVA</b> стр. 16	 <b>PENALVA 1</b> стр. 16	 <b>BASALGO 1</b> стр. 18	 <b>TRONO 2</b> стр. 20	 <b>TRONO STICK</b> стр. 20	 <b>AGOLADA</b> стр. 20	 <b>RIGA-LED</b> стр. 22
 <b>RIGA-LED</b> стр. 23	 <b>RIGA</b> стр. 24	 <b>RIGA</b> стр. 24	 <b>ASCOLI</b> стр. 25	 <b>STOCKHOLM 1</b> стр. 25	 <b>CABOS</b> стр. 25	 <b>RIGA</b> стр. 25	 <b>HELSINKI</b> стр. 26
 <b>HELSINKI</b> стр. 27	 <b>NISIA</b> стр. 28	 <b>OHIO</b> стр. 28	 <b>NISIA 1</b> стр. 29	 <b>ROFFIA</b> стр. 30	 <b>CALGARY</b> стр. 31	 <b>KONYA</b> стр. 32	 <b>BEVERLY</b> стр. 32
 <b>RAVARINO</b> стр. 32	 <b>ROBLEDO</b> стр. 33	 <b>REDONDO</b> стр. 35	 <b>ATOLLARI</b> стр. 34	 <b>MORINO</b> стр. 34	 <b>SERVOI</b> стр. 36	 <b>COVALE</b> стр. 36	 <b>BOSARO</b> стр. 37
 <b>JORBA</b> стр. 38	 <b>PERAFITA</b> стр. 39	 <b>SESIMBA</b> стр. 40	 <b>SESIMBA 1</b> стр. 40	 <b>ONCALA</b> стр. 42	 <b>COMIO</b> стр. 42	 <b>VOLPINO</b> стр. 43	 <b>OROPOS</b> стр. 43
 <b>TABO-LED</b> стр. 44	 <b>PIAS</b> стр. 44	 <b>PARDELA 1</b> стр. 44	 <b>CALGARY 1</b> стр. 44	 <b>SITIA</b> стр. 45	 <b>TABO</b> стр. 46	 <b>ZAMORANA</b> стр. 46	 <b>ACATE</b> стр. 47
 <b>KIBEА</b> стр. 48	 <b>SOJO</b> стр. 48	 <b>NADELA</b> стр. 48	 <b>PREDAZZO</b> стр. 48	 <b>PARK</b> стр. 50	 <b>PARK</b> стр. 50	 <b>MALGERA</b> стр. 50	 <b>BREGANZO</b> стр. 50

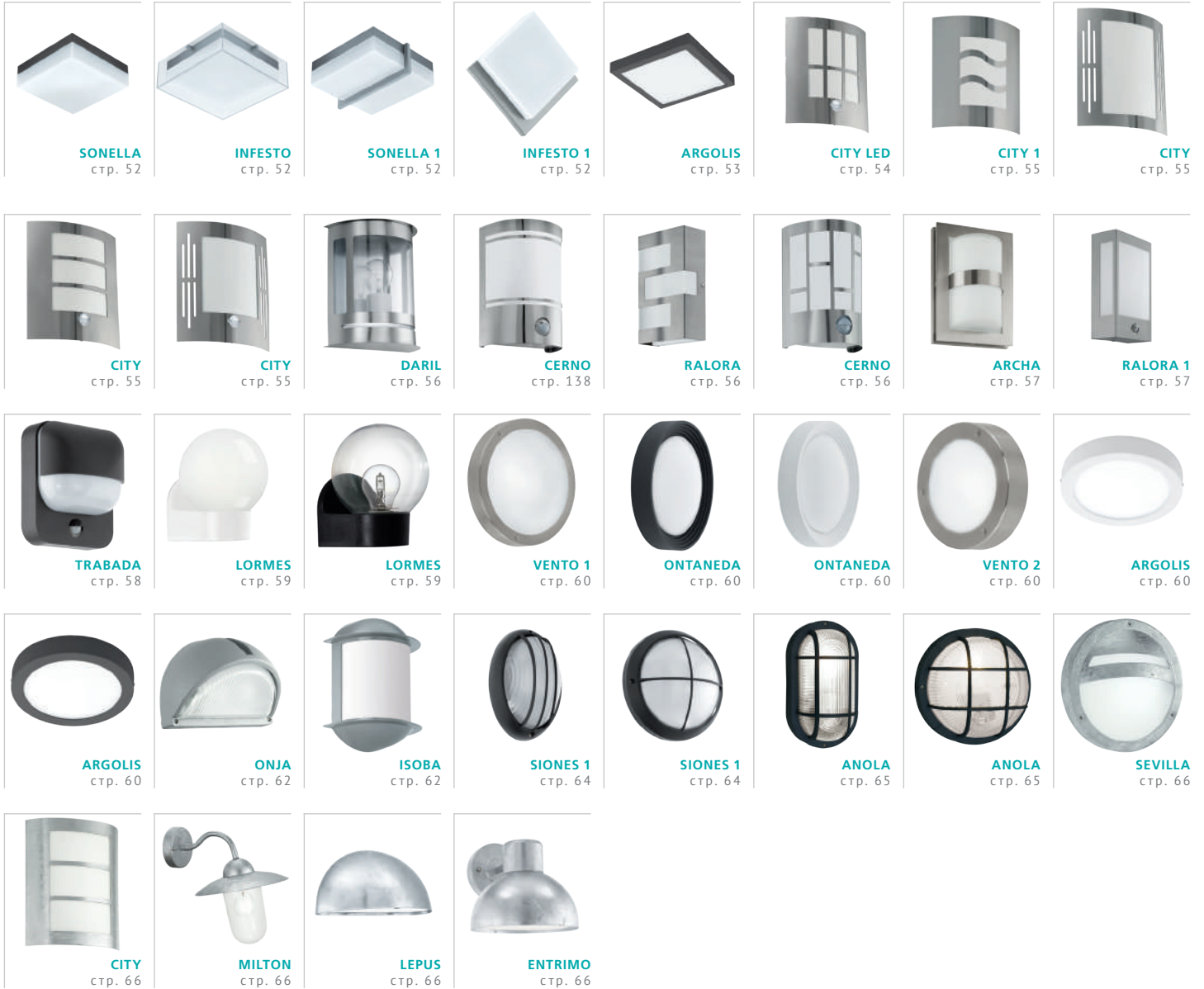

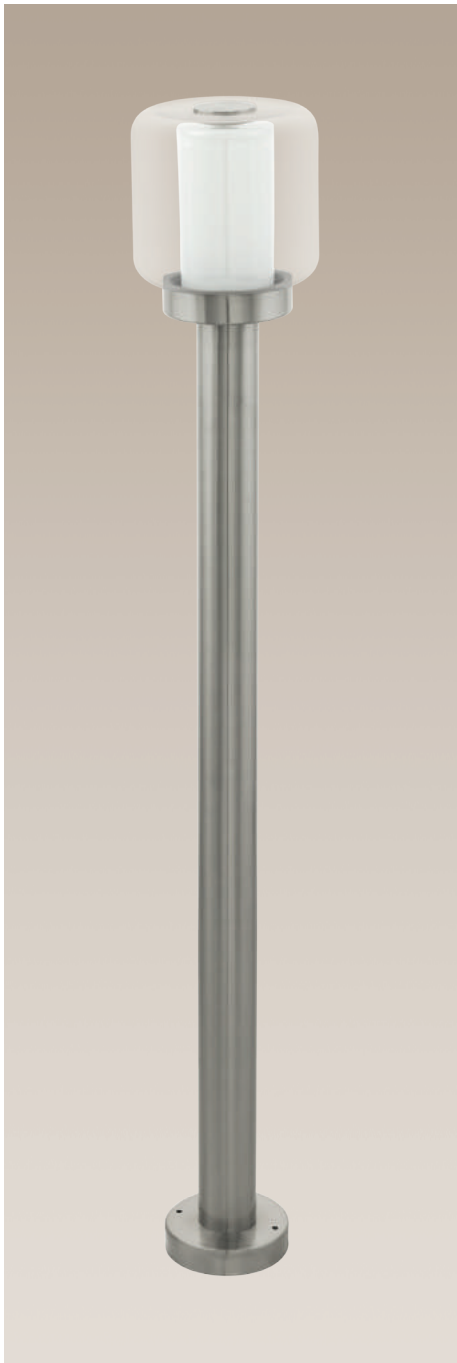

### 95019 POLIENTO

фонарь; нержавеющая сталь, сталь / стекло, прозрачный, белый

H 1000, Ø 150, Base: Ø 115

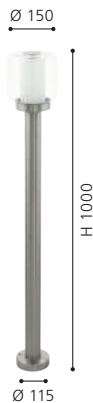

9 002759 950194



### 95016 POLIENTO

настенный светильник; нержавеющая сталь, сталь / стекло, прозрачный, белый

L 150, H 325, A 195



9 002759 950163



### 95017 POLIENTO

настенный светильник; нержавеющая сталь, сталь / стекло, прозрачный, белый

L 150, H 325, A 195



9 002759 950170



### 95018 POLIENTO

наземный светильник; нержавеющая сталь, сталь / стекло, прозрачный, белый

H 500, Ø 150, Base: Ø 115



9 002759 950187







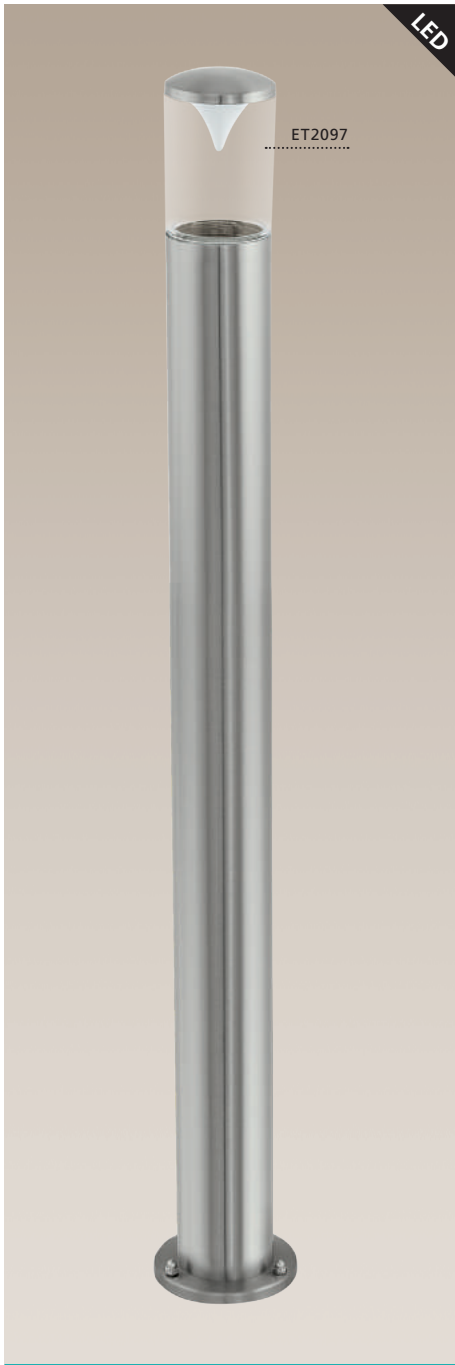

### 94813 PENALVA

наземный светильник; нержавеющая сталь, сталь / пластик, прозрачный, белый

L 75, H 995, Base: Ø 115



IP44



9 002759 948139

A+ WARM WHITE

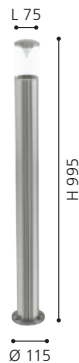

### 94811 PENALVA

настенный светильник; нержавеющая сталь, сталь / пластик, прозрачный, белый

L 75, H 225, A 110



IP44



9 002759 948115

A+ WARM WHITE



### 94817 PENALVA 1

настенный светильник; гальванизированная сталь, черный / пластик, прозрачный, золотой

L 75, H 225, A 110



IP44



9 002759 948177

A+ WARM WHITE



### 94812 PENALVA

настенный светильник; нержавеющая сталь, сталь / пластик, прозрачный, белый

L 75, H 335, A 110

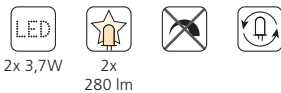

IP44



9 002759 948122

A+ WARM WHITE



### 94818 PENALVA 1

настенный светильник; гальванизированная сталь, черный / пластик, прозрачный, золотой

L 75, H 335, A 110

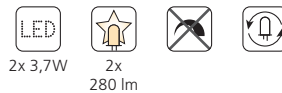

IP44



9 002759 948184

A+ WARM WHITE

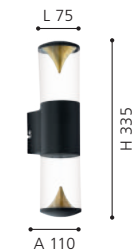



### 94819 PENALVA 1

наземный светильник; гальваническая сталь, черный / пластик, прозрачный, золотой

L 75, H 995, Base: Ø 115



1x 3,7W



1x 280 lm



IP44



9 002759 948191

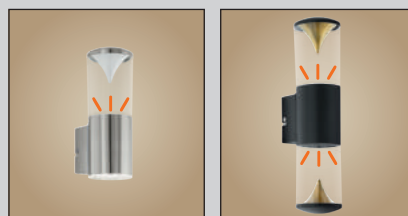

Благодаря освещению вверх или вверх/вниз светильники создают интересный световой эффект.



### 94277 BASALGO 1

настенный светильник; нержавеющая сталь, сталь / пластик, прозрачный, белый

L 105, H 180, A 210

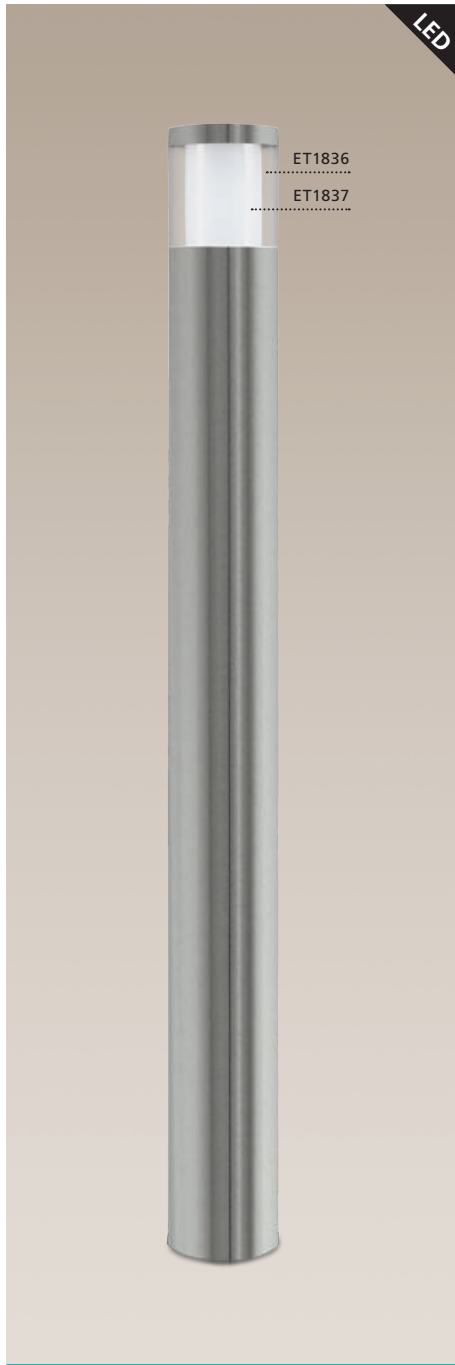

### 94279 BASALGO 1

наземный светильник; нержавеющая сталь, сталь / пластик, прозрачный, белый

H 1050, Ø 105

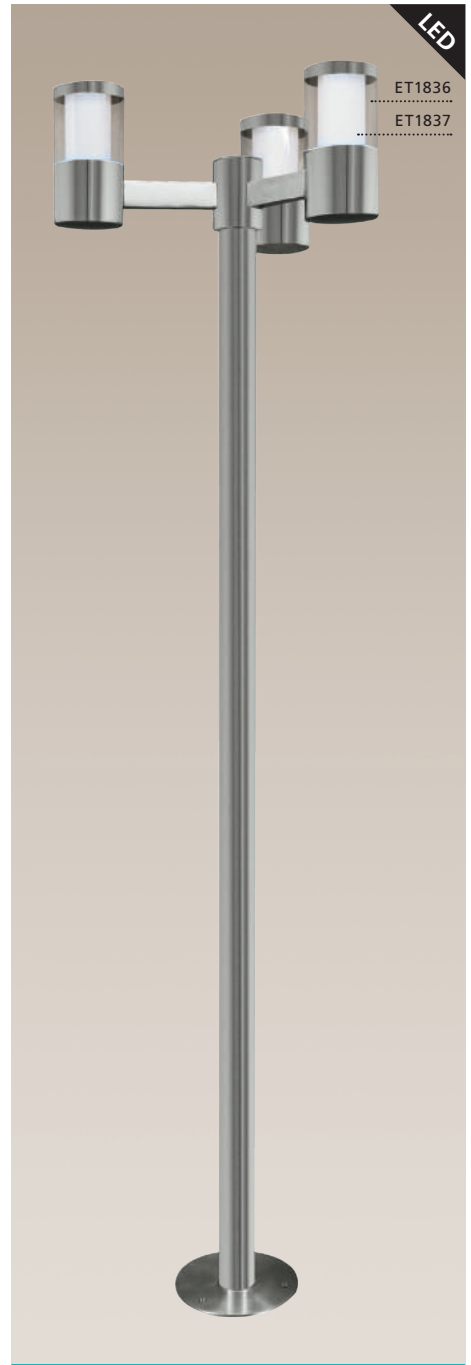
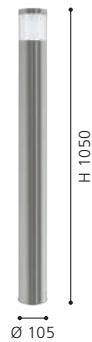

### 94281 BASALGO 1

фонарь; нержавеющая сталь, сталь / пластик, прозрачный, белый

H 1900, Ø 490

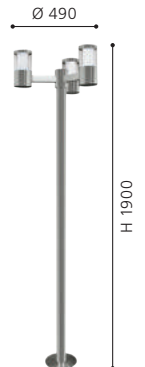





### 94125 TRONO 2

настенный светильник; нержавеющая сталь, сталь / стекло, кристалл, прозрачный



### 94127 TRONO STICK

настенный светильник; нержавеющая сталь, сталь / стекло, пластик, прозрачный



### 94128 TRONO STICK

настенный светильник; нержавеющая сталь, сталь / стекло, пластик, прозрачный

L 105, H 350, A 115

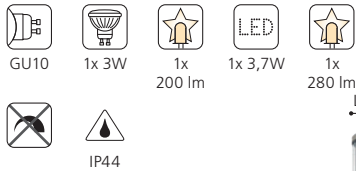

L 105, H 350, A 115

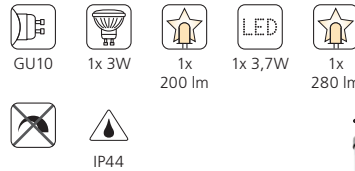

L 105, H 410, A 175

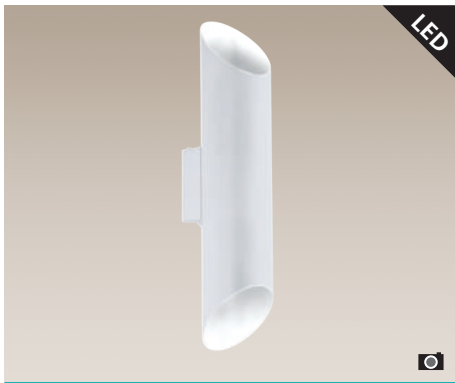

### 94802 AGOLADA

настенный светильник; гальванизированная сталь, белый

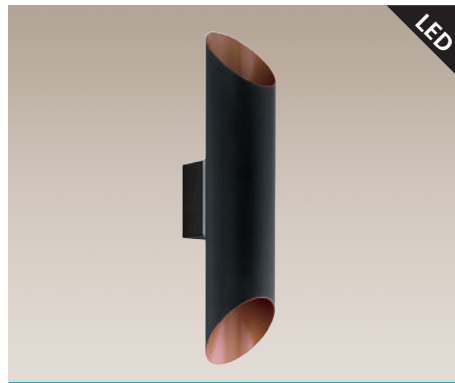

### 94804 AGOLADA

настенный светильник; гальванизированная сталь, черный, медный

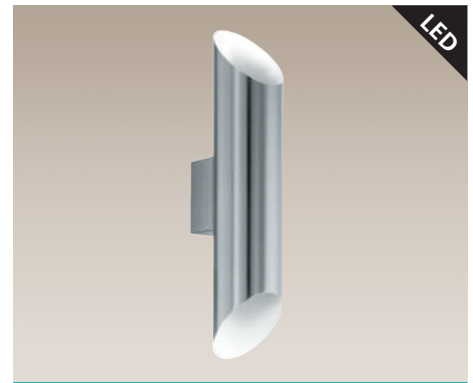

### 94803 AGOLADA

настенный светильник; нержавеющая сталь, белый

L 75, H 360, A 110



L 75, H 360, A 110



L 75, H 360, A 110

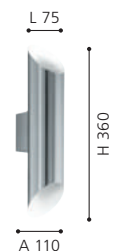





### 92735 RIGA-LED

настенный светильник; нержавеющая сталь, сталь / пластик, матовый

L 65, H 160, A 95



### 92736 RIGA-LED

настенный светильник; нержавеющая сталь, сталь / пластик, матовый

L 65, H 205, A 95

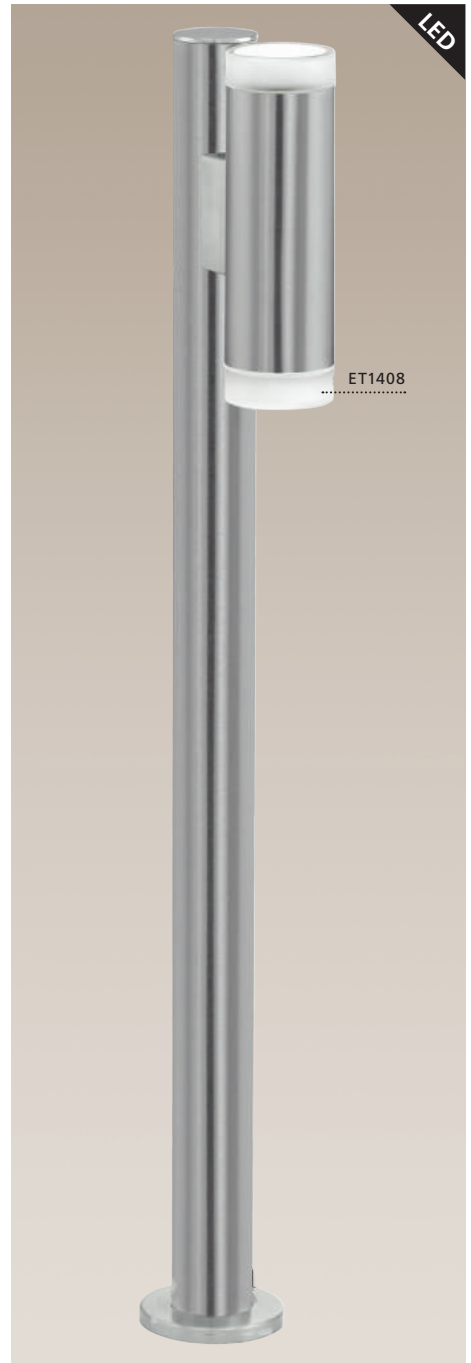
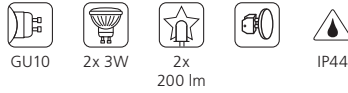

### 92738 RIGA-LED

наземный светильник; нержавеющая сталь, сталь / пластик, матовый

L 130, B 65, H 805, Base: Ø 90

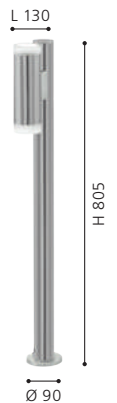
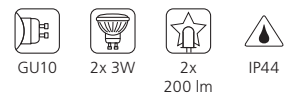

### 92737 RIGA-LED

наземный светильник; нержавеющая сталь, сталь / пластик, матовый

L 130, B 65, H 355, Base: Ø 90

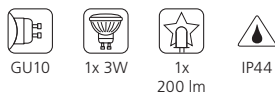





### 96505 RIGA-LED

настенный светильник; гальванизированная сталь, черный / пластик матовый

L 65, H 205, A 100



GU10



2x 5W



2x  
400 lm



IP44



9 002759 965051



WARM  
WHITE



### 96504 RIGA-LED

настенный светильник; гальванизированная сталь, белый / пластик матовый

L 65, H 205, A 100



GU10



2x 5W



2x  
400 lm



IP44



9 002759 965044



WARM  
WHITE





### 94105 RIGA

настенный светильник; гальванизированная сталь, коричневый состаренный

L 65, H 200, A 95

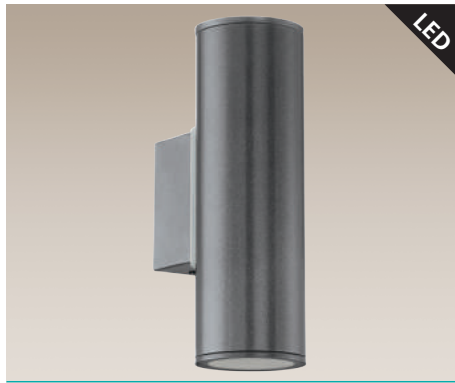

### 94103 RIGA

настенный светильник; гальванизированная сталь, антрацит

L 65, H 200, A 95

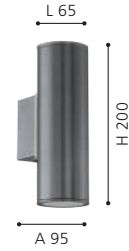

### 94101 RIGA

настенный светильник; гальванизированная сталь, белый

L 65, H 200, A 95



### 94104 RIGA

настенный светильник; гальванизированная сталь, коричневый состаренный

L 65, H 150, A 95

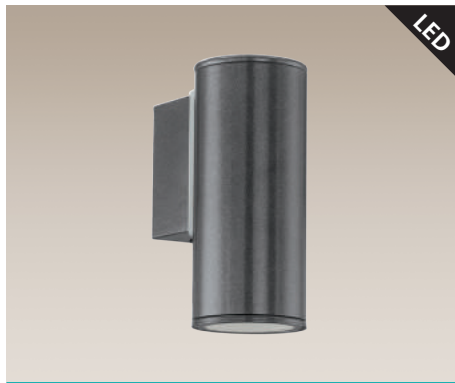

### 94102 RIGA

настенный светильник; гальванизированная сталь, антрацит

L 65, H 150, A 95



### 94099 RIGA

настенный светильник; гальванизированная сталь, белый

L 65, H 150, A 95



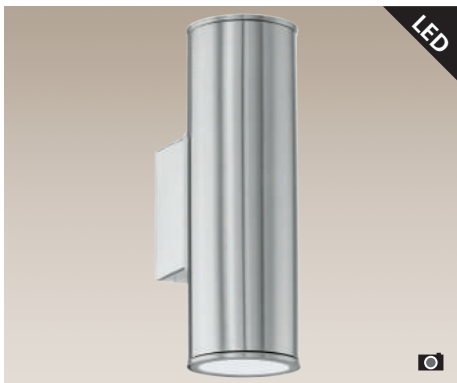

### 94107 RIGA

настенный светильник; нержавеющая сталь, сталь

L 65, H 200, A 95

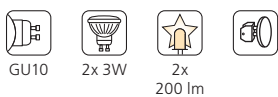

### 94106 RIGA

настенный светильник; нержавеющая сталь, сталь

L 65, H 150, A 95

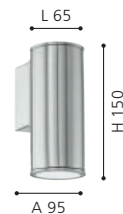
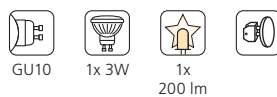

### 90121 ASCOLI

настенный светильник; нержавеющая сталь, сталь / стекло, прозрачный

L 125, H 325, A 160

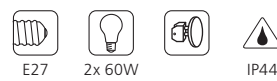

### 93271 CABOS

настенный светильник; нержавеющая сталь, сталь / стекло, матовый

L 75, H 210, A 90

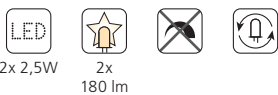

### 93268 STOCKHOLM 1

настенный светильник; нержавеющая сталь, сталь / стекло, прозрачный

Ø 65

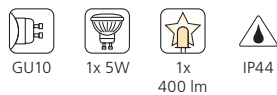

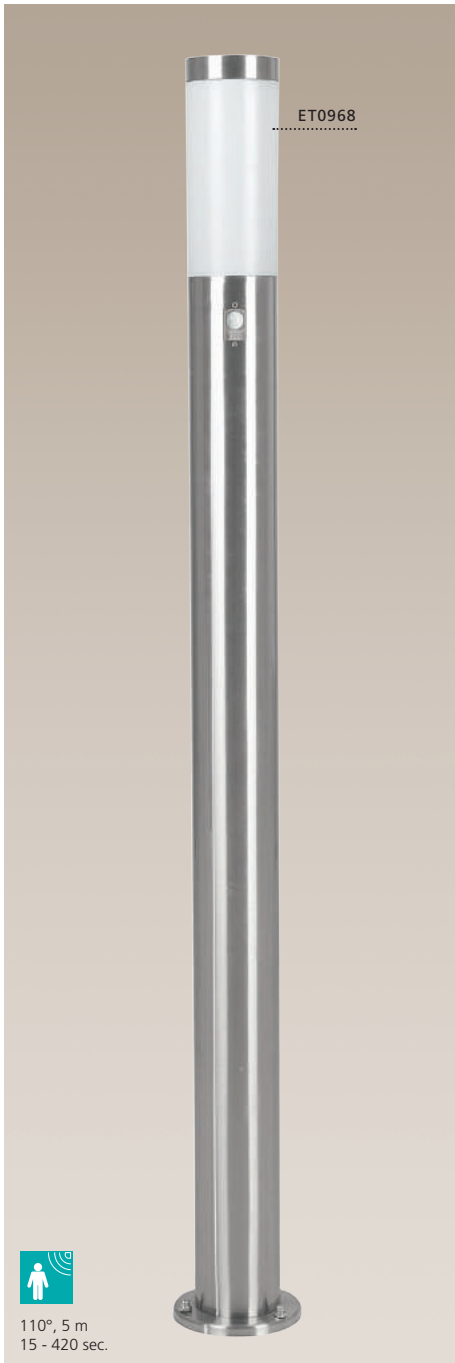

110°, 5 m  
15 - 420 sec.

### 83281 HELSINKI

наземный светильник; нержавеющая сталь, сталь / пластик, белый



### 81752 HELSINKI

наземный светильник; нержавеющая сталь, сталь / пластик, белый



110°, 5 m  
15 - 420 sec.

### 83279 HELSINKI

наземный светильник; нержавеющая сталь, сталь / пластик, белый

H 450, Ø 75, Base: Ø 115



E27



1x 15W



IP44



9 002759 832797



A++-B



### 81751 HELSINKI

наземный светильник; нержавеющая сталь, сталь / пластик, белый

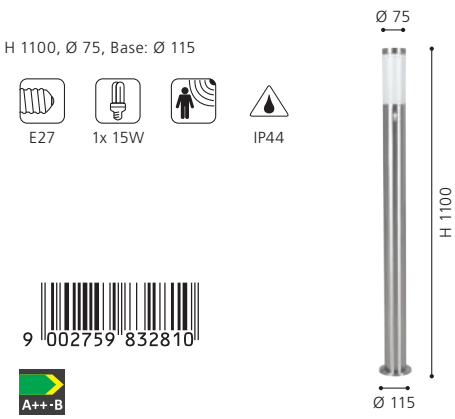

H 1100, Ø 75, Base: Ø 115



E27 1x 15W IP44



9 002759 832810



A++-B

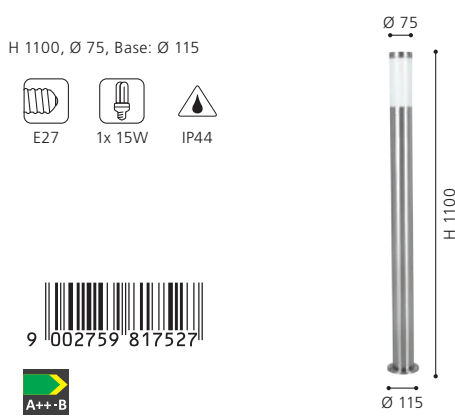

H 1100, Ø 75, Base: Ø 115



E27 1x 15W IP44



9 002759 817527



A++-B

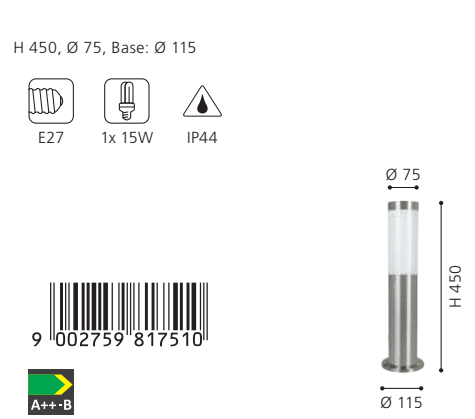

H 450, Ø 75, Base: Ø 115



E27 1x 15W IP44



9 002759 817510



A++-B

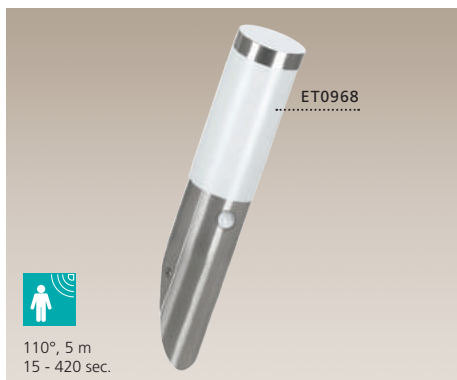

### 83278 HELSINKI

настенный светильник; нержавеющая сталь, сталь / пластик, белый

H 425, Ø 75, A 165



E27



1x 15W



IP44

Ø 75



H 425

A 165



9 002759 832780

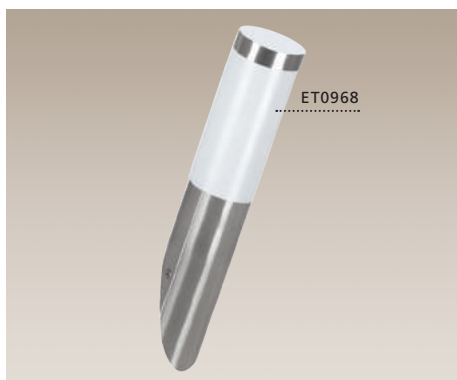

### 81753 HELSINKI

настенный светильник; нержавеющая сталь, сталь / пластик, белый

H 390, Ø 75, A 165



E27



1x 15W



IP44

Ø 75



H 390

A 165



9 002759 817534





### 30207 NISIA

наземный светильник; нержавеющая сталь, сталь / стекло матовое, белый

H 1000, Ø 200

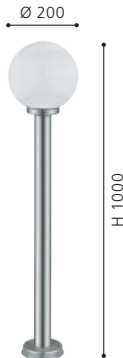

### 27126 NISIA

настенный светильник; нержавеющая сталь, сталь / стекло, белый

H 343, Ø 200



### 30206 NISIA

наземный светильник; нержавеющая сталь, сталь / стекло матовое, белый

H 500, Ø 200, Base: Ø 130

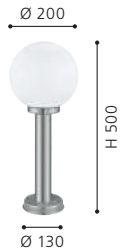

### 30205 NISIA

настенный светильник; нержавеющая сталь, сталь / стекло матовое, белый

L 200, H 360, A 240

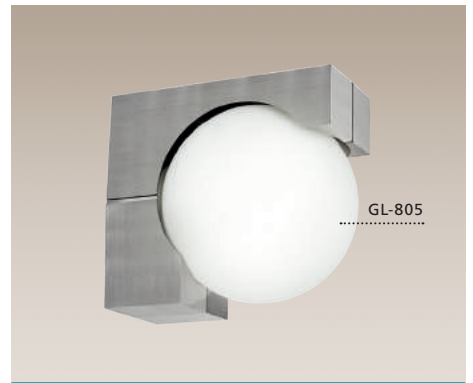
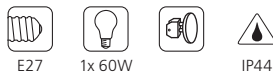

### 89314 OHIO

настенный светильник; литой алюминий, сталь / опаловое стекло, белый

L 190, H 215, A 235

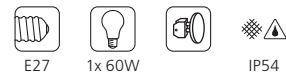



### 93366 NISIA 1

настенный светильник; нержавеющая сталь, сталь / стекло с проволокой, прозрачный, алюминий

H 360, Ø 200, A 240



E27



1x 60W



IP44



9 002759 933661

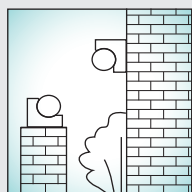

### 89314

Светильник подходит для настенного и наземного крепления

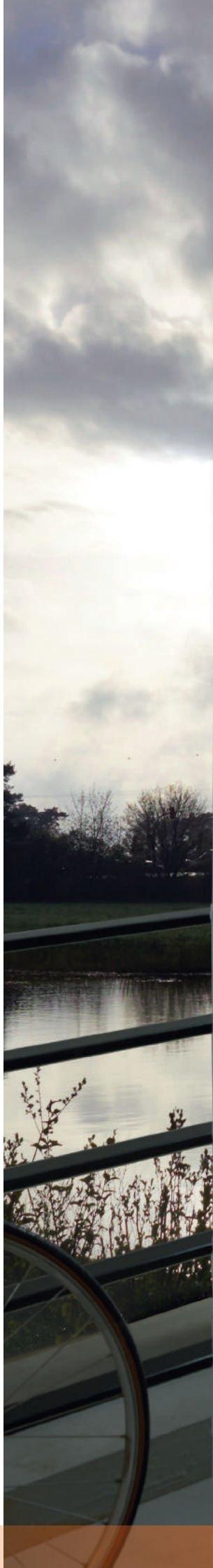

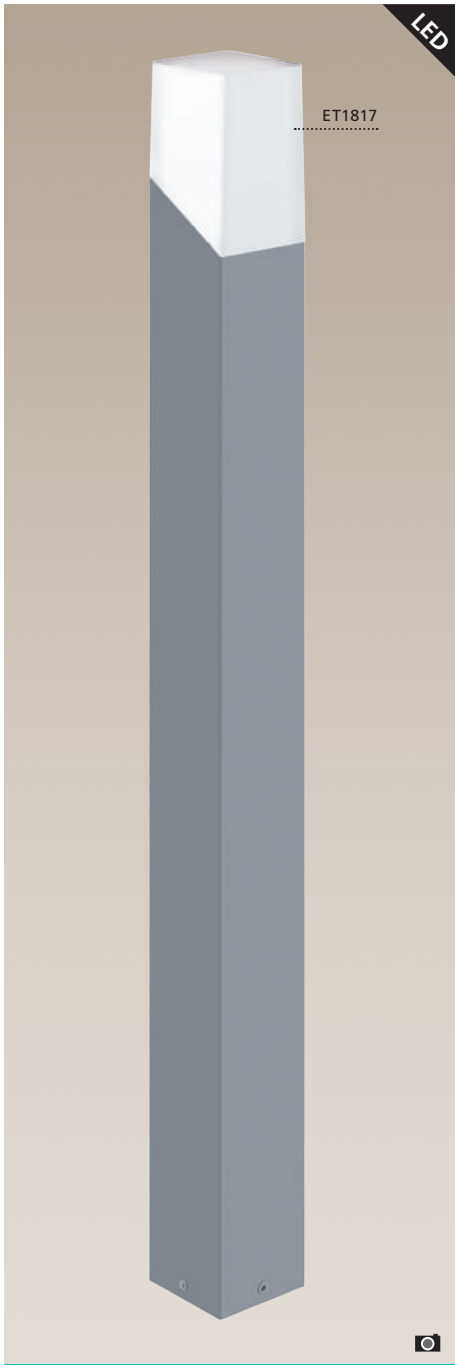

**94088 ROFFIA**

наземный светильник; алюминий, серебряный / пластик, белый

L 90, B 90, H 1000

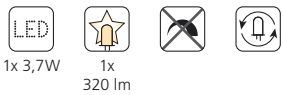

9 002759 940881



**94087 ROFFIA**

настенный светильник; алюминий, серебряный / пластик, белый

L 90, H 210, A 120



9 002759 940874

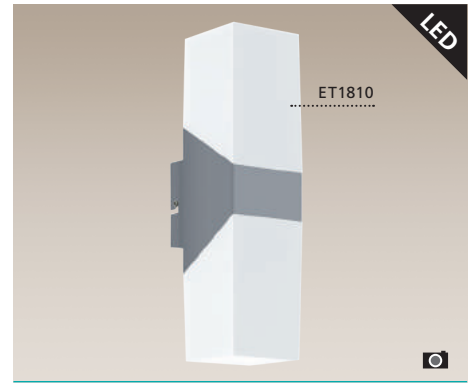

**94118 ROFFIA**

настенный светильник; алюминий, серебряный / пластик, белый

L 90, H 340, A 120



9 002759 941185

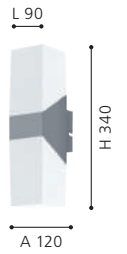



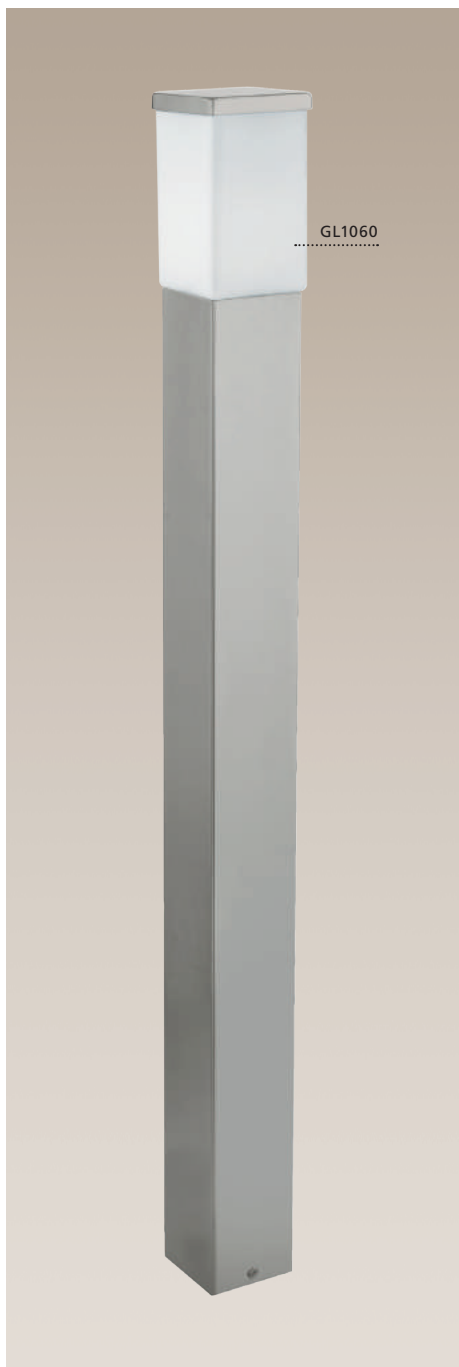

### 86389 CALGARY

наземный светильник; нержавеющая сталь, сталь / опаловое стекло, белый

L 100, B 100, H 1100, Base: B 90, T 90



E27



1x 60W



IP44

B 100



H 1100



9 002759 863890



### 86388 CALGARY

наземный светильник; нержавеющая сталь, сталь / опаловое стекло, белый

L 100, B 100, H 435, Base: B 90, T 90



E27



1x 60W



IP44

B 100



H 435



9 002759 863883



### 86387 CALGARY

настенный светильник; нержавеющая сталь, сталь / опаловое стекло, белый

L 100, H 270, A 120, Base: B 90, T 90



E27



1x 60W



IP44

L 100



H 270



9 002759 863876





### 86541 BEVERLY

настенный светильник; нержавеющая сталь, сталь, серебряный / стекло матовое, белый

L 200, H 350, A 135

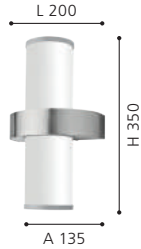

### 94119 RAVARINO

настенный светильник; алюминий, серебряный / пластик, белый

L 140, H 270, A 110



### 86385 KONYA

настенный светильник; нержавеющая сталь, сталь / стекло матовое, белый

L 80, H 215, A 120

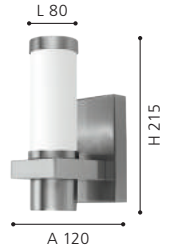
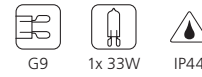

### 86248 KONYA

наземный светильник; нержавеющая сталь, сталь / стекло матовое, белый

H 350, Base: Ø 90

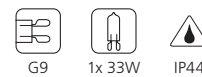



### 96014 ROBLEDO

настенный светильник; гальванизированная сталь, антрацит / пластик, прозрачный

L 75, H 260, A 120



2x 3,7W



2x  
320 lm



IP44



9 002759 960148



WARM  
WHITE

L 75



H 260

A 120



### 96013 ROBLEDO

настенный светильник; нержавеющая сталь, сталь / пластик, прозрачный

L 75, H 260, A 120



2x 3,7W



2x  
320 lm



IP44



9 002759 960131



WARM  
WHITE

L 75



H 260

A 120





### 93319 MORINO

настенный светильник; литой алюминий, антрацит

L 140, H 180, A 105

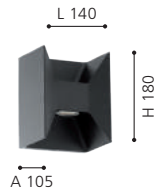

### 96276 ATOLLARI

настенный светильник; литой алюминий, антрацит / пластик, белый

L 100, H 230, A 155

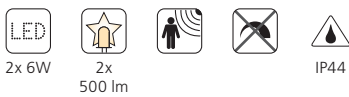

### 96277 ATOLLARI

настенный светильник; литой алюминий, сталь, серебряный / пластик, белый

L 100, H 230, A 155

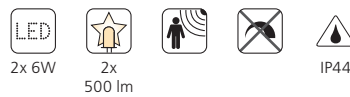

### 93318 MORINO

настенный светильник; литой алюминий, белый

L 140, H 180, A 105

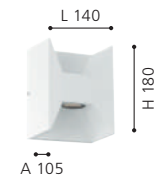



### 93367 REDONDO

настенный светильник; литой алюминий, белый

L 160, H 175, A 125



2x 2,5W



2x  
180 lm



IP44



9 002759 933678



### 93368 REDONDO

настенный светильник; литой алюминий, антрацит

L 160, H 175, A 125



2x 2,5W



2x  
180 lm



IP44



9 002759 933685





### 95992 SERVOI

настенный светильник; гальванизированная сталь, антрацит / пластик, прозрачный

L 100, H 250, A 85



### 95991 SERVOI

настенный светильник; гальванизированная сталь, белый / пластик, прозрачный

L 100, H 250, A 85



### 96015 COVALE

настенный светильник; нержавеющая сталь, сталь / пластик, белый

L 75, H 285, A 125



### 96016 COVALE

настенный светильник; гальванизированная сталь, антрацит / пластик, белый

L 75, H 285, A 125

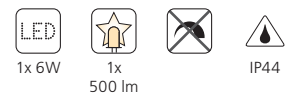



**93991 BOSARO**

настенный светильник; гальванизированная сталь, белый

L 170, H 270, A 105



2x 2,5W



2x  
180 lm



IP44



9 002759 939915



**94779 BOSARO**

настенный светильник; нержавеющая сталь, сталь

L 170, H 270, A 105



2x 2,5W



2x  
180 lm



IP44



9 002759 947798





### 96256 JORBA

настенный светильник; литой алюминий, антрацит / пластик, белый

L 110, H 110, A 110



1x 6W



1x  
500 lm



IP44



9 002759 962562

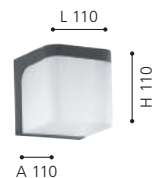

A+



WARM  
WHITE



### 96255 JORBA

настенный светильник; литой алюминий, белый / пластик, белый

L 110, H 110, A 110



1x 6W



1x  
500 lm



IP44



9 002759 962555

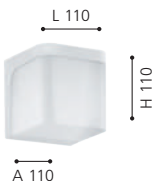

A+



WARM  
WHITE





### 96007 PERAFITA

настенный светильник; литой алюминий, антрацит / пластик, белый

L 175, H 170, A 95



2x 6W



2x

500 lm



IP44



9 002759 960070



L 175



H 170

A 95



### 96006 PERAFITA

настенный светильник; литой алюминий, белый / пластик, белый

L 175, H 170, A 95



2x 6W



2x

500 lm



IP44



9 002759 960063



L 175



H 170

A 95



### 94849 SESIMBA

настенный светильник; сталь, белый / пластик, прозрачный



### 94848 SESIMBA

настенный светильник; гальванизированная сталь, черный / пластик, прозрачный



### 94796 SESIMBA

настенный светильник; гальванизированная сталь, серебряный / пластик, прозрачный

L 130, H 195, A 140



L 130, H 195, A 140



L 130, H 195, A 140



### 96022 SESIMBA 1

настенный светильник; гальванизированная сталь, белый / пластик, прозрачный

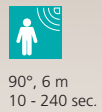

L 130, H 195, A 140

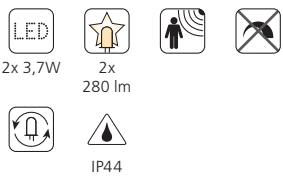

### 96021 SESIMBA 1

настенный светильник; гальванизированная сталь, черный / пластик, прозрачный

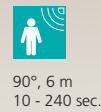

L 130, H 195, A 140

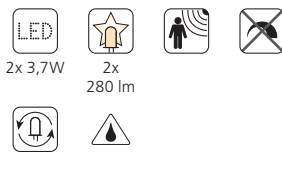

### 96019 SESIMBA 1

настенный светильник; гальванизированная сталь, серебряный / пластик, прозрачный

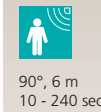

L 130, H 195, A 140

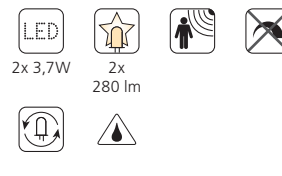





### 95981 ONCALA

настенный светильник; гальванизированная сталь, черный / стекло матовое, белый

L 150, H 140, A 190



### 95982 ONCALA

настенный светильник; нержавеющая сталь, сталь / стекло матовое, белый

L 150, H 140, A 190



### 95986 COMIO

фонарь; гальванизированная сталь, антрацит / пластик, прозрачный

B 110, H 1020, Base: Ø 110

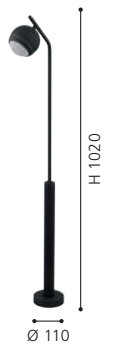

### 95985 COMIO

настенный светильник; гальванизированная сталь, антрацит / пластик, прозрачный

Ø 110, A 135





### 91769 VOLPINO

настенный светильник; гальванизированная сталь, серебряный / пластик, белый

L 290, H 115, A 60

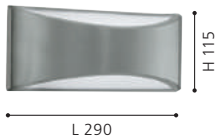
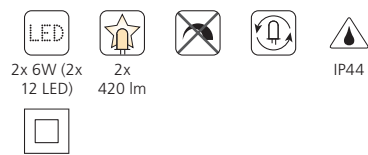

### 96238 OROPOS

настенный светильник; гальванизированная сталь, антрацит / пластик, белый

Ø 250, A 75



### 96237 OROPOS

настенный светильник; гальванизированная сталь, серебряный / пластик, белый

Ø 250, A 75



### 96237, 96238

1x A-F      3x 0-9

Буквы и цифры входят в комплект светильника.



### 93365 PIAS

настенный светильник; нержавеющая сталь, сталь

L 150, H 250, A 55



### 93364 TABO-LED

настенный светильник; нержавеющая сталь, сталь

L 80, H 195, A 110



### 94114 CALGARY 1

настенный светильник; нержавеющая сталь, сталь / пластик, белый

L 200, H 200, A 95

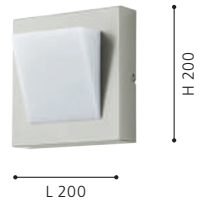

### 93369 PARDELA 1

настенный светильник; нержавеющая сталь, сталь

L 170, H 280, A 100

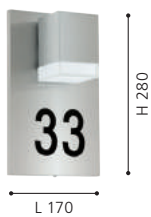

### 93369

1x A-F 3x 0-9

Буквы и цифры входят в комплект светильника.



### 95988 SITIA

настенный светильник; гальванизированная сталь, антрацит / пластик, белый

L 180, H 180, A 55



2x 4,8W



2x  
550 lm



IP44



9 002759 959883



L 180

H 180



### 95987 SITIA

настенный светильник; гальванизированная сталь, никель матовый / пластик, белый

L 180, H 180, A 55



2x 4,8W



2x  
550 lm



IP44



9 002759 959876



L 180

H 180





### 94793 ZAMORANA

настенный светильник; нержавеющая сталь, сталь

L 65, H 165, A 65

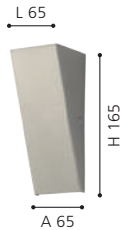

### 94794 ZAMORANA

настенный светильник; нержавеющая сталь, сталь

L 95, H 215, A 95

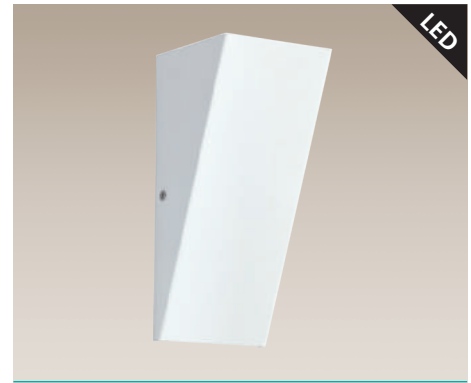
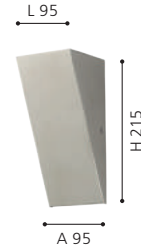

### 94851 ZAMORANA

настенный светильник; гальванизированная сталь, белый

L 95, H 215, A 95

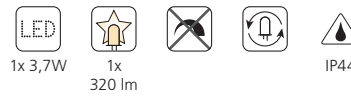

### 94184 TABO

потолочный светильник; алюминий, серебряный

L 75, B 75, H 80

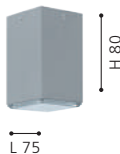
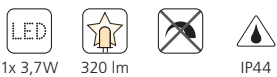

### 94185 TABO

настенный светильник; алюминий, серебряный

L 75, B 75, H 140, A 105

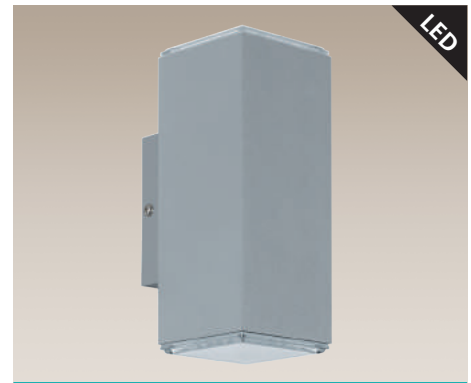
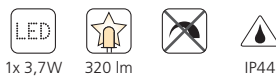

### 94186 TABO

настенный светильник; алюминий, серебряный

L 75, B 75, H 195, A 105

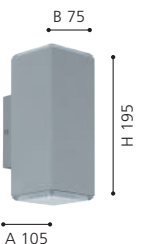
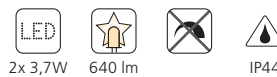



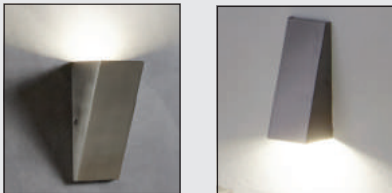

### ZAMORANO

Эти светильники возможно устанавливать с направлением света вверх и вниз.



### 94845 ACATE

настенно-потолочный светильник; алюминий, сталь, серебряный / пластик, белый

L 100, H 350, A 60



8W



770 lm



IP44



9 002759 948450

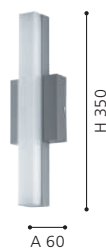



### 93256 SOJO

настенный светильник; гальванизированная сталь, белый

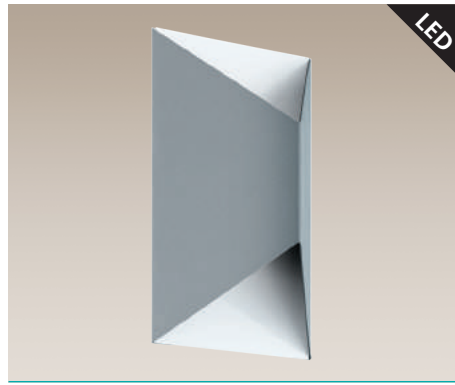

### 93993 PREDAZZO

настенный светильник; гальванизированная сталь, серебряный, белый



### 93994 PREDAZZO

настенный светильник; гальванизированная сталь, антрацит, белый

L 180, H 265, A 135



L 140, H 210, A 75



L 140, H 210, A 75

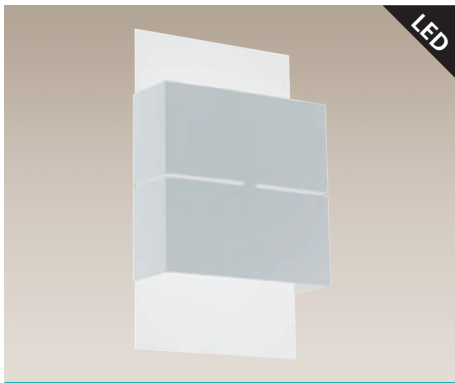

### 93253 KIBEA

настенный светильник; гальванизированная сталь, белый



### 93254 KIBEA

настенный светильник; гальванизированная сталь, белый, антрацит



### 93438 NADELA

настенный светильник; нержавеющая сталь, сталь / стекло матовое, белый

L 150, H 260, A 75



L 150, H 260, A 75



L 215, H 290, A 90

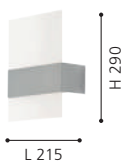





### 94138 BREGANZO

настенный светильник; гальванизированная сталь, антрацит / пластик, белый

### 94137 BREGANZO

настенный светильник; гальванизированная сталь, серебряный / пластик, белый

### 94133 MALGERA

настенный светильник; гальванизированная сталь, серебряный / пластик, белый

L 180, H 250, A 115



L 180, H 250, A 115



L 170, H 270, A 115



### 83433 PARK

настенный светильник; литой алюминий, антрацит / стекло матовое, белый

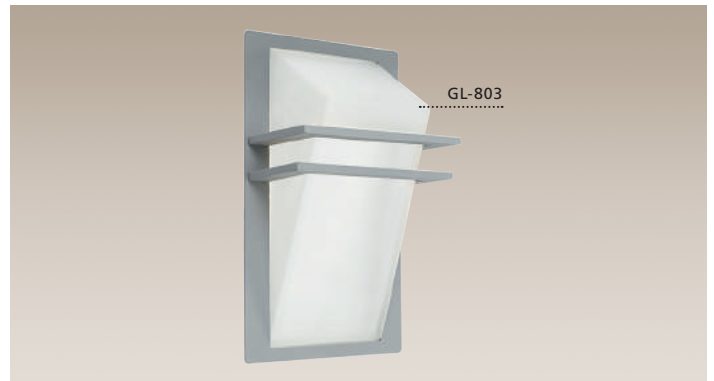

### 83432 PARK

настенный светильник; литой алюминий, серебряный / стекло матовое, белый

L 200, H 350, A 145



L 200, H 350, A 145





### 96018 BREGANZO 1

настенный светильник; гальванизированная сталь, антрацит / пластик, белый

L 190, H 300, A 125



2x 2,5W



2x  
180 lm



IP44



### 96017 BREGANZO 1

настенный светильник; гальванизированная сталь, серебряный / пластик, белый

L 190, H 300, A 125



2x 2,5W



2x  
180 lm



IP44





### 94871 SONELLA

настенно-потолочный светильник; пластик, белый / пластик, белый

L 215, H 215, A 70

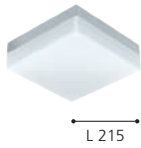

### 94872 SONELLA

настенно-потолочный светильник; пластик, антрацит / пластик, белый

L 215, H 215, A 70

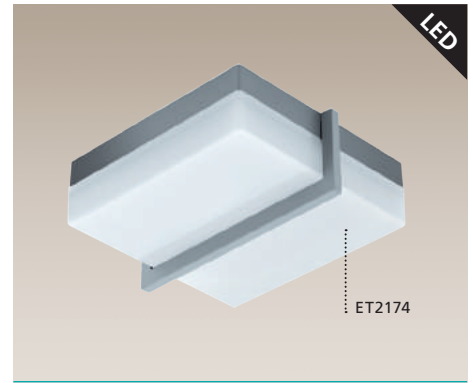
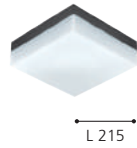

### 94876 SONELLA 1

настенно-потолочный светильник; пластик, алюминий, антрацит / пластик, белый

L 215, H 240, A 85

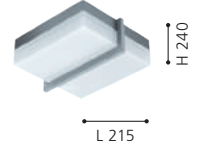

### 94877 INFESTO 1

настенно-потолочный светильник; нержавеющая сталь, пластик, сталь, серебряный / пластик, белый

L 250, H 250, A 70

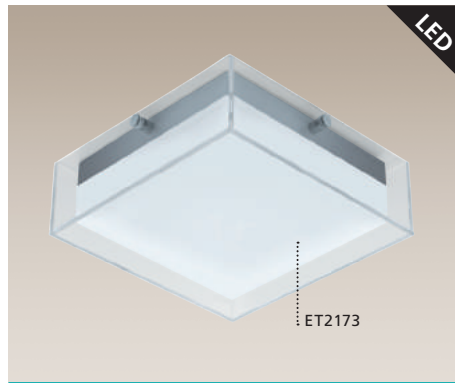
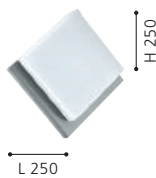

### 94874 INFESTO

настенно-потолочный светильник; пластик, сталь, серебряный / стекло, пластик, прозрачный, антрацит

L 250, H 250, A 85

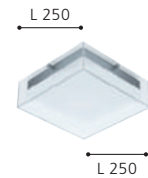



### 96494 ARGOLIS

настенно-потолочный светильник; литой алюминий, белый / пластик, белый

L 300, B 300, H 40

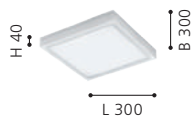

### 96495 ARGOLIS

настенно-потолочный светильник; литой алюминий, антрацит / пластик, белый

L 300, B 300, H 40



22W



2600 lm



IP44

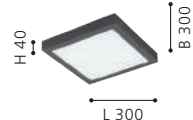



### 94213 CITY LED

настенный светильник; нержавеющая сталь, сталь / пластик, белый

L 235, H 260, A 90



### 94212 CITY LED

настенный светильник; нержавеющая сталь, сталь / пластик, белый

L 235, H 260, A 90

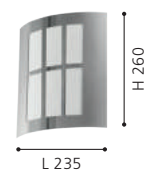





### 88144 CITY

настенный светильник; нержавеющая сталь, сталь / пластик, белый

L 235, H 260, A 90

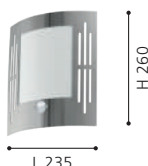

### 88142 CITY

настенный светильник; нержавеющая сталь, сталь / пластик, белый

L 235, H 260, A 90



### 30194 CITY 1

настенный светильник; нержавеющая сталь, сталь / пластик, белый

L 230, H 300, A 90

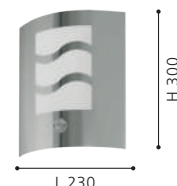

### 82309 CITY

настенный светильник; нержавеющая сталь, сталь / пластик, белый

L 235, H 260, A 90



### 88139 CITY

настенный светильник; нержавеющая сталь, сталь / пластик, белый

L 235, H 260, A 90

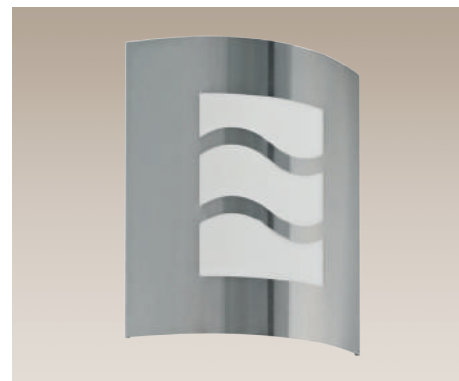
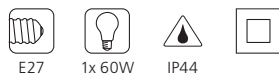

### 30193 CITY 1

настенный светильник; нержавеющая сталь, сталь / пластик, белый

L 230, H 300, A 90

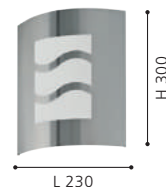
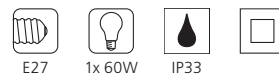



### 30191 CERNO

настенный светильник; нержавеющая сталь, сталь / стекло матовое, белый



### 30192 CERNO

настенный светильник; нержавеющая сталь, сталь / стекло матовое, белый



### 30173 DARIL

настенный светильник; нержавеющая сталь, сталь / пластик, прозрачный

L 140, H 165, A 105



L 140, H 190, A 110

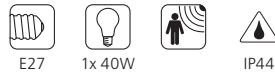

L 195, H 240, A 110



### 94797 CERNO

настенный светильник; нержавеющая сталь, сталь / стекло матовое, белый



### 94798 CERNO

настенный светильник; нержавеющая сталь, сталь / стекло матовое, белый



### 94086 RALORA

настенный светильник; нержавеющая сталь, сталь / пластик, белый

L 135, H 165, A 105

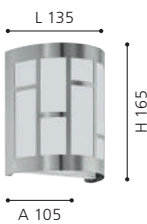

L 135, H 200, A 105



L 140, H 240, A 70





### 89366 ARCHA

настенный светильник; литой алюминий, сталь, никель матовый / корродированное стекло, белый

L 220, H 330, A 112



E27



1x 60W



IP54

L 220



H 330

A 112



9 002759 893668



### 95989 RALORA 1

настенный светильник; нержавеющая сталь, сталь / пластик, белый

L 170, H 290, A 100



12W



1000 lm



IP44

L 170



H 290

A 100



9 002759 959890



WARM WHITE



### 89366



Этот светильник оснащен съемными элементами из нержавеющей стали



### 95073 TRABADA

настенный светильник; литой алюминий, белый / пластик, белый

L 160, H 190, A 115



### 94852 TRABADA

настенный светильник; литой алюминий, черный / пластик, белый

L 160, H 190, A 115

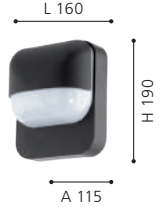
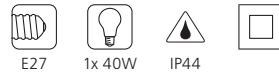

### 95074 TRABADA

настенный светильник; литой алюминий, белый / пластик, белый

L 160, H 190, A 115



### 94853 TRABADA

настенный светильник; литой алюминий, черный / пластик, белый

L 160, H 190, A 115

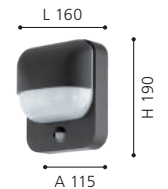



### 96583 LORMES

настенный светильник; пластик, белый / пластик, белый

L 150, H 195, A 165

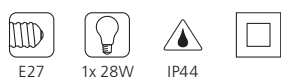

### 96584 LORMES

настенный светильник; пластик, черный / пластик, прозрачный

L 150, H 195, A 165

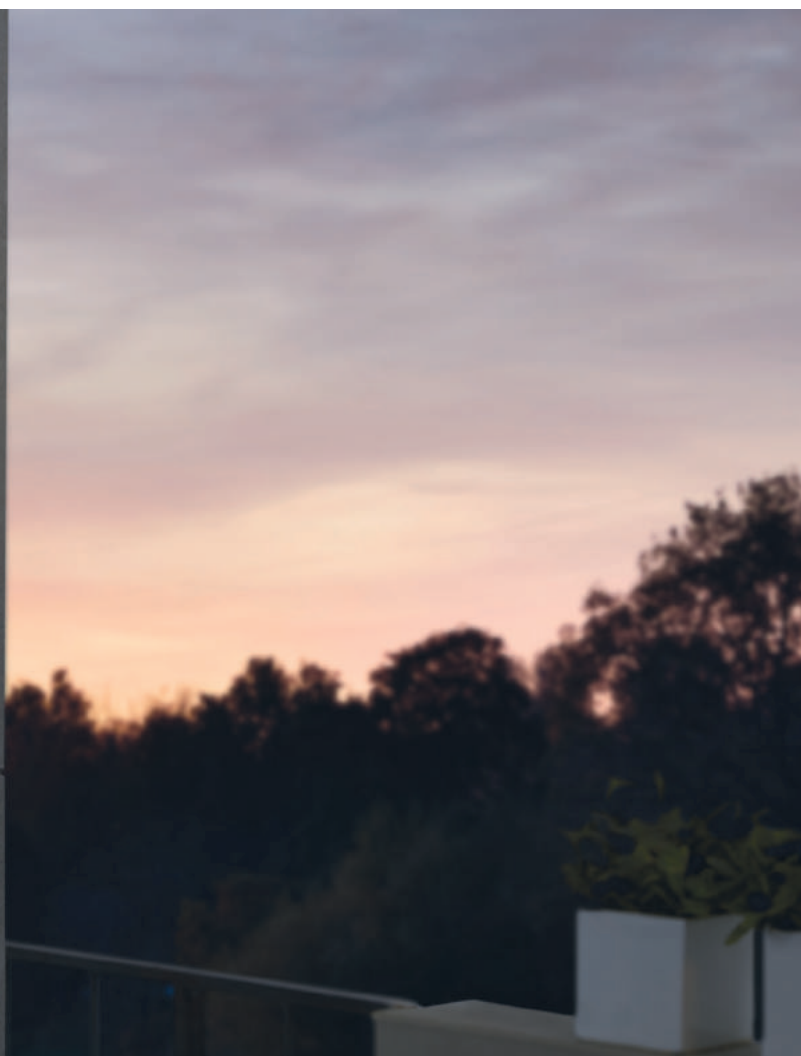
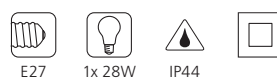



### 96491 ARGOLIS

настенно-потолочный светильник; литой алюминий, белый / пластик, белый

H 35, Ø 225

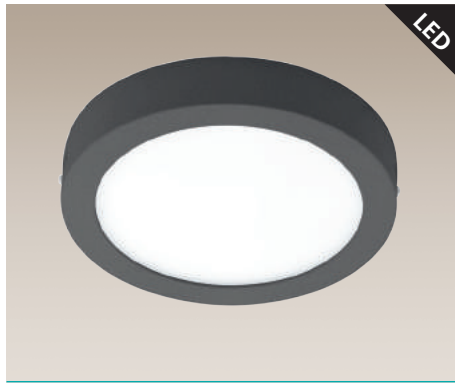
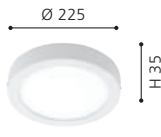

### 96492 ARGOLIS

настенно-потолочный светильник; литой алюминий, антрацит / пластик, белый

H 35, Ø 225



### 96365 VENTO 2

настенно-потолочный светильник; нержавеющая сталь, сталь / пластик, белый

Ø 185, A 70



### 94785 ONTANEDA

настенно-потолочный светильник; пластик, белый / пластик, белый

Ø 325, A 75



### 94784 ONTANEDA

настенно-потолочный светильник; пластик, черный / пластик, белый

Ø 325, A 75



### 94121 VENTO 1

настенно-потолочный светильник; нержавеющая сталь, сталь / стекло, белый лак

Ø 285, A 80







### 89768 ONJA

настенный светильник; литой алюминий, белый / рифленое стекло, прозрачный

L 220, H 155, A 150

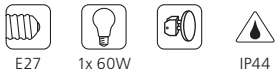

### 89769 ONJA

настенный светильник; литой алюминий, серебряный / рифленое стекло, прозрачный

L 220, H 155, A 150

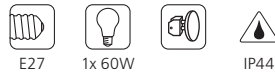

### 89767 ONJA

настенный светильник; литой алюминий, черный / рифленое стекло, прозрачный

L 220, H 155, A 150

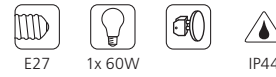

### ONJA

Благодаря освещению вверх/вниз светильники создают интересный световой эффект.



### 96353 ISOBA

настенный светильник; литой алюминий, белый / пластик, белый

L 160, H 220, A 105

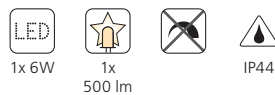

WARM WHITE



### 96354 ISOBA

настенный светильник; литой алюминий, серебряный / пластик, белый

L 160, H 220, A 105



WARM WHITE

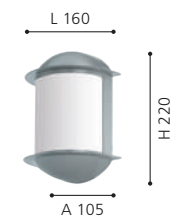







### 96338 SIONES 1

настенно-потолочный светильник; литой алюминий, белый / структурное стекло, белый

L 145, H 215, A 100

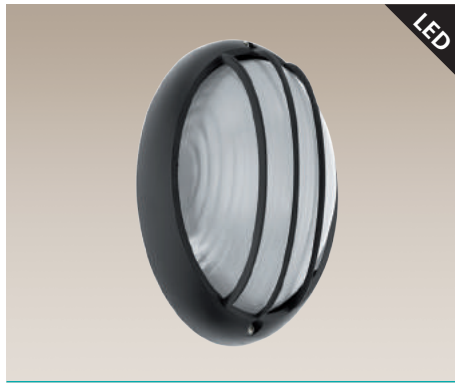

### 96339 SIONES 1

настенно-потолочный светильник; литой алюминий, черный / структурное стекло, белый

L 145, H 215, A 100

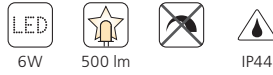

### 96341 SIONES 1

настенно-потолочный светильник; литой алюминий, белый / структурное стекло, белый

Ø 260, A 100



### 96342 SIONES 1

настенно-потолочный светильник; литой алюминий, черный / структурное стекло, белый

Ø 260, A 100





### 88807 ANOLA

настенно-потолочный светильник; пластик, белый / стекло, прозрачный

Ø 185, A 100



E27



1x 40W



10x



IP44



9 002759 888077



Ø 185



A 100



### 88803 ANOLA

настенно-потолочный светильник; пластик, черный / стекло, прозрачный

Ø 185, A 100



E27



1x 40W



10x



IP44



9 002759 888039



Ø 185



A 100



### 88802 ANOLA

настенно-потолочный светильник; пластик, черный / стекло, прозрачный

L 203, B 113, A 94



E27



1x 40W



10x



IP44



9 002759 888022



B 113



A 94

L 203





### 88489 MILTON

настенный светильник; сталь, оцинкованная сталь / стекло, прозрачный

H 310, A 310



### 88119 SEVILLA

настенно-потолочный светильник; сталь, оцинкованная сталь / стекло матовое, белый

Ø 285, A 83



### 96206 ENTRIMO

настенный светильник; гальванизированная сталь, оцинкованная сталь / пластик, белый

L 200, H 185, A 235

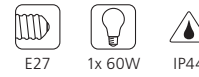

### 88487 CITY

настенный светильник; нержавеющая сталь, оцинкованная сталь / пластик, белый

L 235, H 260, A 90

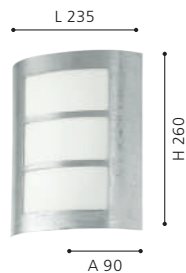
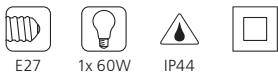

### 90867 LEPUS

настенный светильник; сталь, оцинкованная сталь / пластик, белый

L 235, H 120, A 125





















































15 лет гарантии против коррозии на покрытия из оцинкованной стали.



Классика

 <b>COMUNERO</b> стр. 70	 <b>ALAMONTE</b> стр. 72	 <b>ALAMONTE 1</b> стр. 74	 <b>BARROSELA</b> стр. 76	 <b>HILBURN 1</b> стр. 76	 <b>HILBURN</b> стр. 78	 <b>PULFERO</b> стр. 80	 <b>PULFERO 1</b> стр. 82
 <b>MONASTERIO</b> стр. 84	 <b>MONASTERIO</b> стр. 84	 <b>MELGOA</b> стр. 86	 <b>BARROSELA</b> стр. 86	 <b>COLINDRES 1</b> стр. 86	 <b>COLINDRES</b> стр. 87	 <b>BARROSELA</b> стр. 87	 <b>MELGOA</b> стр. 87
 <b>ENTRIMO</b> стр. 88	 <b>TOLLERA</b> стр. 88	 <b>FACUNDA</b> стр. 88	 <b>ALBACETE</b> стр. 88	 <b>MAMURRA</b> стр. 90	 <b>APIMARE</b> стр. 90	 <b>APIMARE</b> стр. 90	 <b>VALDEO</b> стр. 90
 <b>SESIMBA</b> стр. 92	 <b>BREGANZO</b> стр. 92	 <b>SEVILIA</b> стр. 92	 <b>ALAMONTE 2</b> стр. 92	 <b>ISOBA</b> стр. 92	 <b>ALORIA</b> стр. 95	 <b>SIDNEY</b> стр. 96	 <b>ALORIA</b> стр. 98
 <b>LISIO</b> стр. 100	 <b>MOUNA</b> стр. 102	 <b>MINORCA</b> стр. 104	 <b>MILTON</b> стр. 105	 <b>SAN TELMO</b> стр. 105	 <b>NABILA 1</b> стр. 105	 <b>NAVEDO</b> стр. 106	 <b>LATERNA 7</b> стр. 107
 <b>NAVEDO</b> стр. 108	 <b>NAVEDO</b> стр. 109	 <b>NAVEDO</b> стр. 110	 <b>LATERNA 5</b> стр. 112	 <b>LATERNA 5</b> стр. 113	 <b>LATERNA 4</b> стр. 114	 <b>LATERNA 4</b> стр. 115	 <b>OUTDOOR CLASSIC</b> стр. 117



### 96297 COMUNERO

фонарь; литой алюминий, черный, серебряный / пластик, прозрачный, белый

H 1000, Ø 175, Base: Ø 110

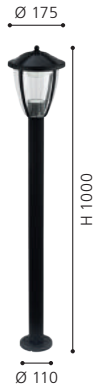

9 002759 962975



### 96295 COMUNERO

настенный светильник; литой алюминий, черный, серебряный / пластик, прозрачный, белый

L 175, H 275, A 225

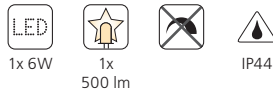

9 002759 962951



### 96294 COMUNERO

настенный светильник; литой алюминий, черный, серебряный / пластик, прозрачный, белый

L 175, H 275, A 225



9 002759 962944



### 96296 COMUNERO

наземный светильник; литой алюминий, черный, серебряный / пластик, прозрачный, белый

H 300, Ø 175, Base: Ø 110



9 002759 962968









GL3394



GL3394

GL3395

### 94786 ALAMONTE

подвесной светильник; нержавеющая сталь, сталь / стекло, прозрачный

L 150, B 150, H 1285

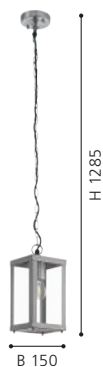

GL3390

GL3391

### 94827 ALAMONTE

настенный светильник; нержавеющая сталь, сталь / стекло, прозрачный

L 170, H 260, A 100



GL3394

### 94787 ALAMONTE

настольная лампа; нержавеющая сталь, сталь / стекло, прозрачный

L 150, B 150, H 275

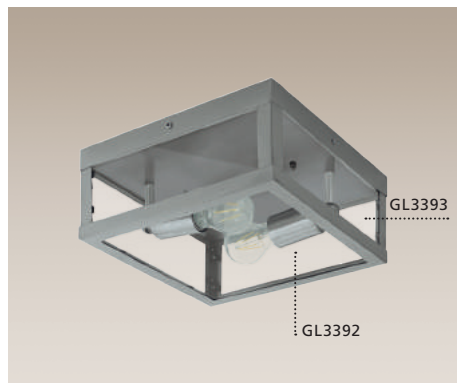
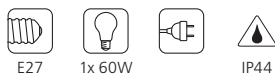

GL3393

GL3392

### 94828 ALAMONTE

настенно-потолочный светильник; нержавеющая сталь, сталь / стекло, прозрачный

L 290, H 290, A 130

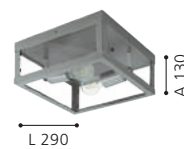
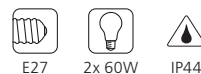

L 150, B 150, H 1015, Base: Ø 110







### 94833 ALAMONTE 1

наземный светильник; гальванизированная сталь, черный / стекло, прозрачный

L 150, B 150, H 1015, Base: Ø 110



### 94788 ALAMONTE 1

подвесной светильник; гальванизированная сталь, черный / стекло, прозрачный

L 150, B 150, H 1285



### 94831 ALAMONTE 1

настенный светильник; гальванизированная сталь, черный / стекло, прозрачный

L 170, H 260, A 100



### 94789 ALAMONTE 1

настольная лампа; гальванизированная сталь, черный / стекло, прозрачный

L 150, B 150, H 275

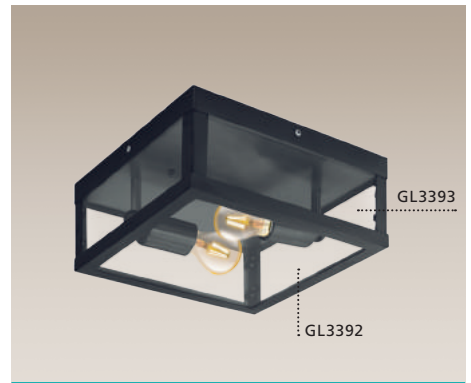
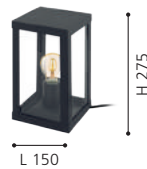
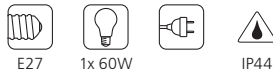

### 94832 ALAMONTE 1

настенно-потолочный светильник; гальванизированная сталь, черный / стекло, прозрачный

L 290, H 290, A 130







### 94868 HILBURN 1

наземный светильник; гальваническая сталь, серебряный состаренный / пластик, прозрачный

L 200, B 135, H 1030

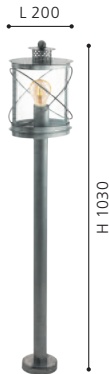

### 94865 HILBURN 1

настенный светильник; гальваническая сталь, серебряный состаренный / пластик, прозрачный

L 200, H 375, A 170

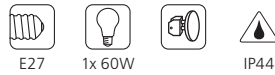

### 94866 HILBURN 1

настенный светильник; гальваническая сталь, серебряный состаренный / пластик, прозрачный

L 200, H 280, A 200

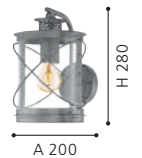
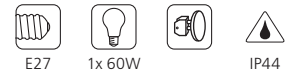

### 94867 HILBURN 1

наземный светильник; гальваническая сталь, серебряный состаренный / пластик, прозрачный

L 200, B 135, H 410



### 94859 BARROSELA

настенный светильник; гальваническая сталь, серебряный состаренный / пластик, белый

L 220, H 240, A 230

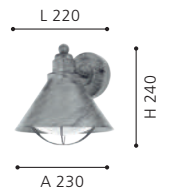
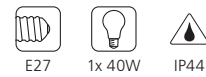





### 94844 HILBURN

наземный светильник; гальваническая сталь, черный / пластик, прозрачный

L 200, B 135, H 1030



### 94842 HILBURN

настенный светильник; гальваническая сталь, черный / пластик, прозрачный

L 200, H 375, A 170

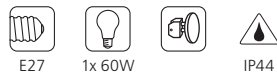

### 94843 HILBURN

настенный светильник; гальваническая сталь, черный / пластик, прозрачный

L 200, H 280, A 200

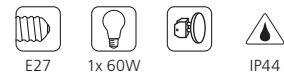

### 94864 HILBURN

наземный светильник; гальваническая сталь, черный / пластик, прозрачный

L 200, B 135, H 410









### 94836 PULFERO

наземный светильник; гальваническая сталь, черный / пластик, прозрачный

H 1020, Ø 220, Base: Ø 110



### 94834 PULFERO

настенный светильник; гальваническая сталь, черный / пластик, прозрачный

L 220, H 280, A 280



### 94841 PULFERO

настенный светильник; гальваническая сталь, черный / пластик, прозрачный

L 220, H 280, A 280



### 94835 PULFERO

наземный светильник; гальваническая сталь, черный / пластик, прозрачный

H 415, Ø 220, Base: Ø 110







### 94857 PULFERO 1

фонарь, гальванизированная сталь, коричневый / пластик, прозрачный

H 1020, Ø 220, Base: Ø 110

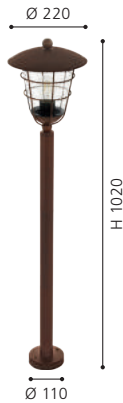

### 94854 PULFERO 1

настенный светильник; гальванизированная сталь, коричневый / пластик, прозрачный

L 220, H 280, A 280



### 94855 PULFERO 1

настенный светильник; гальванизированная сталь, коричневый / пластик, прозрачный

L 220, H 280, A 280



### 94856 PULFERO 1

наземный светильник; гальванизированная сталь, коричневый / пластик, прозрачный

H 415, Ø 220, Base: Ø 110







### 95976 MONASTERIO

настенный светильник; гальванизированная сталь, черный / стекло матовое, белый

L 220, H 265, A 235



### 95978 MONASTERIO

настенный светильник; гальванизированная сталь, серебряный состаренный / стекло матовое, белый

L 220, H 265, A 235

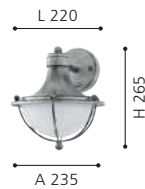

### 95979 MONASTERIO

фонарь; гальванизированная сталь, серебряный состаренный / стекло матовое, белый

L 320, B 220, H 1065, Base: Ø 110



### 95977 MONASTERIO

фонарь; гальванизированная сталь, черный / стекло матовое, белый

L 320, B 220, H 1065, Base: Ø 110







### 94861 COLINDRES 1

подвесной светильник; гальванизированная сталь, черный / пластик, белый



### 94862 COLINDRES 1

настенный светильник; гальванизированная сталь, черный / пластик, белый



### 94805 BARROSELA

настенный светильник; гальванизированная сталь, черный / пластик, белый

H 1270, Ø 215

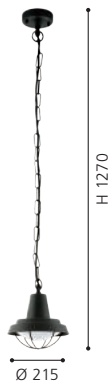

L 215, H 290, A 275



L 220, H 240, A 230



### 94792 MELGOA

настенный светильник; гальванизированная сталь, черный / стекло, прозрачный

L 300, H 250, A 380

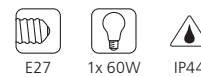





### 94837 COLINDRES

подвесной светильник; гальванизированная сталь, состаренный медный / пластик, белый

H 1270, Ø 215



E27



1x 60W



IP44



H 1270

Ø 215



9 002759 948375



### 94858 BARROSELA

настенный светильник; гальванизированная сталь, состаренный медный / пластик, белый

L 220, H 240, A 230



E27



1x 40W



IP44

L 220



H 240

A 230



9 002759 948580



### 94838 COLINDRES

настенный светильник; гальванизированная сталь, состаренный медный / пластик, белый

L 215, H 290, A 275



E27



1x 60W



IP44

L 215



H 290

A 275



9 002759 948382



### 94863 MELGOA

настенный светильник; гальванизированная сталь, состаренный медный / стекло, прозрачный

L 300, H 250, A 380



E27



1x 60W



IP44

L 300



H 250

A 380



9 002759 948634





### 96207 ENTRIMO

настенный светильник; гальванизированная сталь, черный / пластик, белый

L 200, H 185, A 235



### 96234 TOLLERA

настенный светильник; гальванизированная сталь, серебряный состаренный / пластик, белый

L 225, H 180, A 255



### 96262 ALBACETE

настенный светильник; гальванизированная сталь, коричневый, медный / стекло с пузырьками, прозрачный

L 265, H 255, A 280



### 96236 FACUNDA

настенный светильник; гальванизированная сталь, черный / стекло, прозрачный

L 165, H 355, A 175

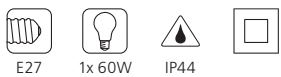

### 96235 TOLLERA

настенный светильник; гальванизированная сталь, состаренный медный / пластик, белый

L 225, H 180, A 255



### 96263 ALBACETE

настенный светильник; гальванизированная сталь, серебряный состаренный / стекло с пузырьками, прозрачный

L 265, H 255, A 280







### 96239 VALDEO

настенный светильник; гальванизированная сталь, черный / стекло, прозрачный

L 165, H 275, A 200



### 96223 MAMURRA

настенный светильник; гальванизированная сталь, коричневый / стекло с пузырьками, прозрачный

L 150, H 345, A 180



### 96232 APIMARE

настенный светильник; гальванизированная сталь, черный / стекло с пузырьками, прозрачный

L 140, H 310, A 215



### 96241 VALDEO

настенный светильник; гальванизированная сталь, состаренный медный / стекло, прозрачный

L 165, H 275, A 200



### 96222 MAMURRA

настенный светильник; гальванизированная сталь, черный / стекло с пузырьками, прозрачный

L 150, H 345, A 180



### 96233 APIMARE

настенный светильник; гальванизированная сталь, темно-коричневый / стекло с пузырьками, прозрачный

L 140, H 310, A 215







### 96267 SESIMBA

настенный светильник; гальванизированная сталь, серебряный состаренный / пластик, прозрачный

L 110, H 110, A 140

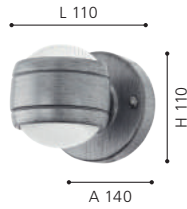

### 96268 SESIMBA

настенный светильник; гальванизированная сталь, темно-коричневый / пластик, прозрачный

L 110, H 110, A 140

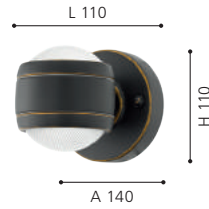

### 96269 BREGANZO

настенный светильник; гальванизированная сталь, темно-коричневый / пластик, белый

L 180, H 250, A 115



### 96272 ALAMONTE 2

настенный светильник; гальванизированная сталь, состаренный медный / стекло, прозрачный

L 170, H 260, A 100



### 96273 ISOBA

настенный светильник; литой алюминий, состаренный медный / пластик, белый

L 160, H 220, A 105

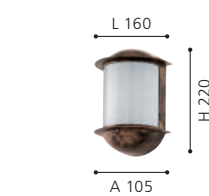
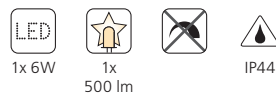

### 96271 SEVILIA

настенный светильник; гальванизированная сталь, состаренный медный / стекло матовое, белый

Ø 285, A 83







### 93409 ALORIA

фонарь; литой алюминий, черный / пластик, прозрачный

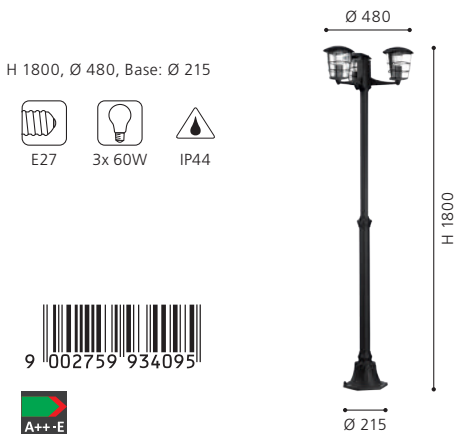

### 93408 ALORIA

наземный светильник; литой алюминий, черный / пластик, прозрачный

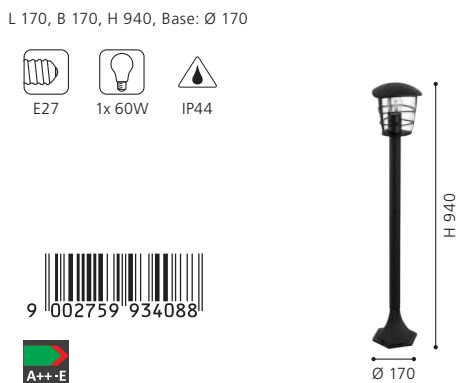

### 93406 ALORIA

подвесной светильник; литой алюминий, черный / пластик, прозрачный

L 170, B 170, H 685

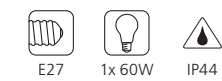

### 93099 ALORIA

наземный светильник; литой алюминий, черный / пластик, прозрачный

L 170, B 170, H 300, Base: Ø 170

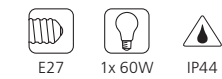





### 93097 ALORIA

настенный светильник; литой алюминий, черный / пластик, прозрачный

L 170, H 225, A 190



E27



1x 60W



IP44



9 002759 930974



### 93098 ALORIA

настенный светильник; литой алюминий, черный / пластик, прозрачный

L 170, H 225, A 190



E27



1x 60W



IP44



9 002759 930981



### 93407 ALORIA

настенный светильник; литой алюминий, черный / пластик, прозрачный

L 180, H 200, A 120



E27



1x 60W



IP44



9 002759 934071



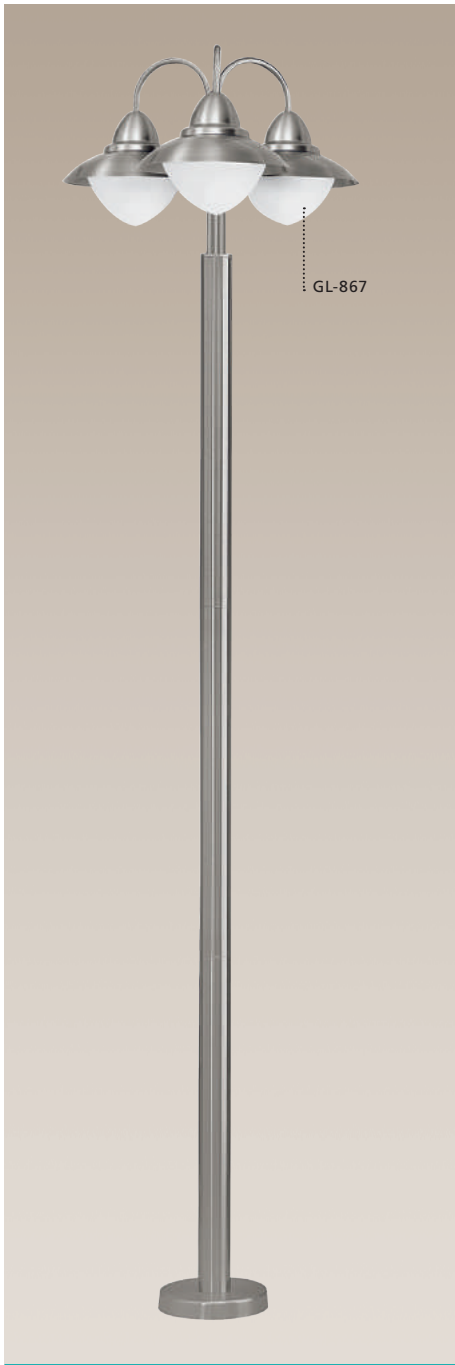

### 83971 SIDNEY

фонарь; нержавеющая сталь, сталь / стекло матовое, белый

H 2200, Ø 600, Base: Ø 200

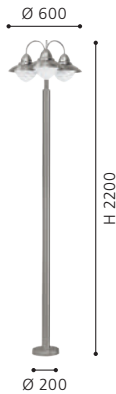

9 002759 839710



### 83969 SIDNEY

наземный светильник; нержавеющая сталь, сталь / стекло матовое, белый

B 350, H 1200, Base: Ø 120

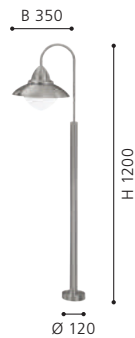

9 002759 839697



### 83966 SIDNEY

настенный светильник; нержавеющая сталь, сталь / стекло матовое, белый

H 375, Ø 270, A 325



9 002759 839666



### 87105 SIDNEY

настенный светильник; нержавеющая сталь, сталь / стекло матовое, белый

H 375, Ø 275, A 325

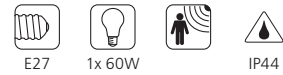

9 002759 871055







### 93405 ALORIA

фонарь; литой алюминий, белый / пластик, прозрачный

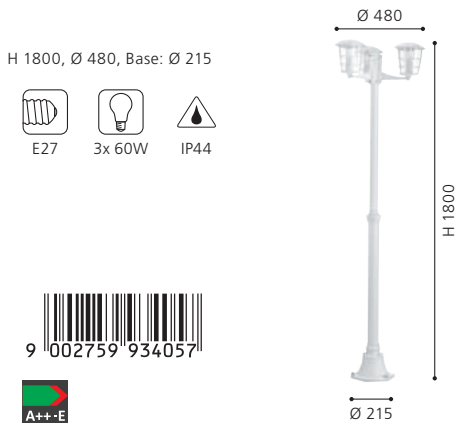

### 93404 ALORIA

наземный светильник; литой алюминий, белый / пластик, прозрачный

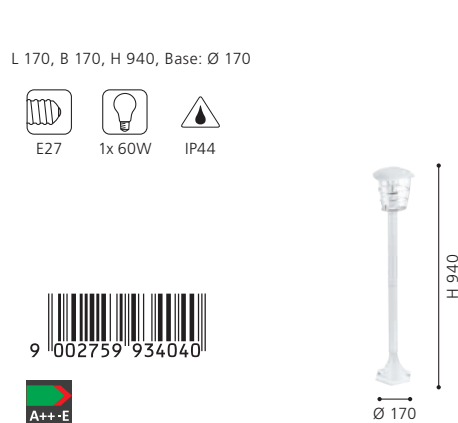

### 93402 ALORIA

подвесной светильник; литой алюминий, белый / пластик, прозрачный

L 170, B 170, H 685

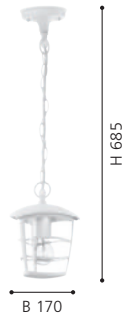

### 93096 ALORIA

наземный светильник; литой алюминий, белый / пластик, прозрачный





### 93094 ALORIA

настенный светильник; литой алюминий, белый / пластик, прозрачный

L 170, H 225, A 190



E27



1x 60W



IP44



9 002759 930943



### 93095 ALORIA

настенный светильник; литой алюминий, белый / пластик, прозрачный

L 170, H 225, A 190



E27



1x 60W



IP44



9 002759 930950



### 93403 ALORIA

настенный светильник; литой алюминий, белый / пластик, прозрачный

L 180, H 200, A 120



E27



1x 60W



IP44



9 002759 934033





### 30186 LISIO

подвесной светильник; нержавеющая сталь, сталь / стекло, прозрачный

H 880, Ø 175



9 002759 301866

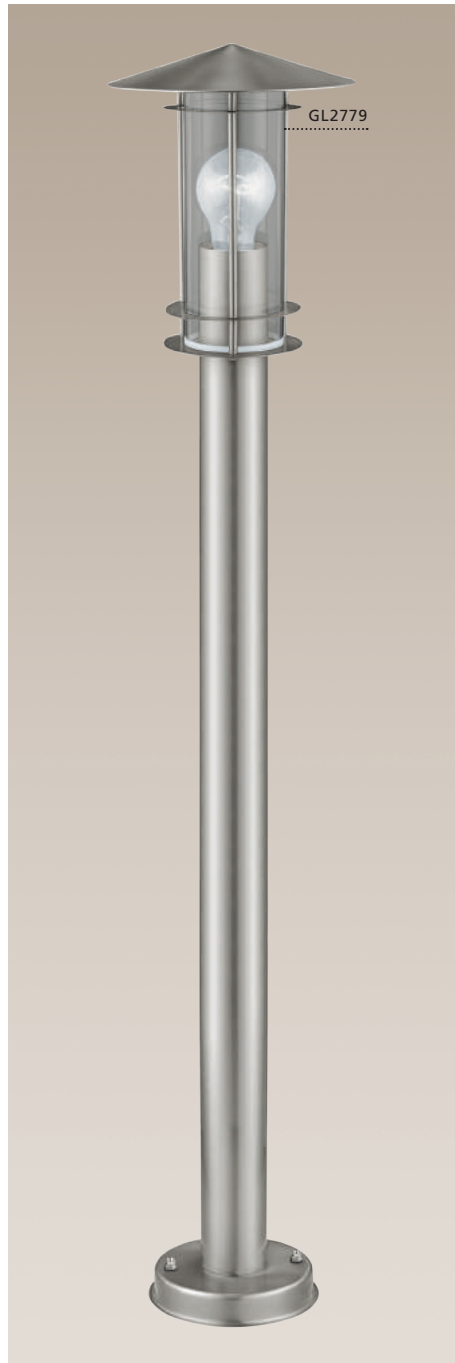

### 30188 LISIO

наземный светильник; нержавеющая сталь, сталь / стекло, прозрачный

H 1000, Ø 175, Base: Ø 130



9 002759 301880

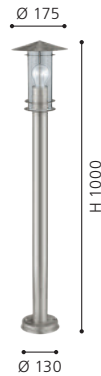

### 30184 LISIO

настенный светильник; нержавеющая сталь, сталь / стекло, прозрачный

L 175, H 300, A 225



9 002759 301842

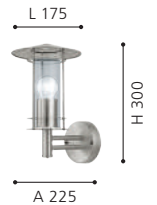

### 30187 LISIO

наземный светильник; нержавеющая сталь, сталь / стекло, прозрачный

H 500, Ø 175, Base: Ø 130



9 002759 301873

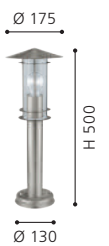

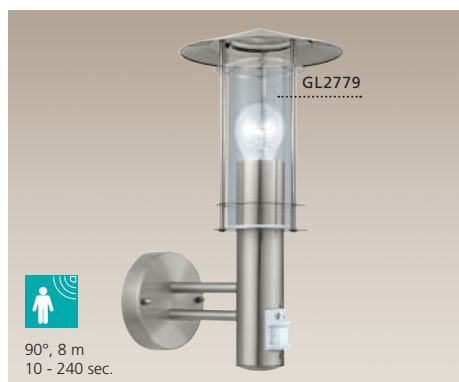

### 30185 LISIO

настенный светильник; нержавеющая сталь, сталь /  
стекло, прозрачный

L 175, H 360, A 225



E27



1x 60W



IP44



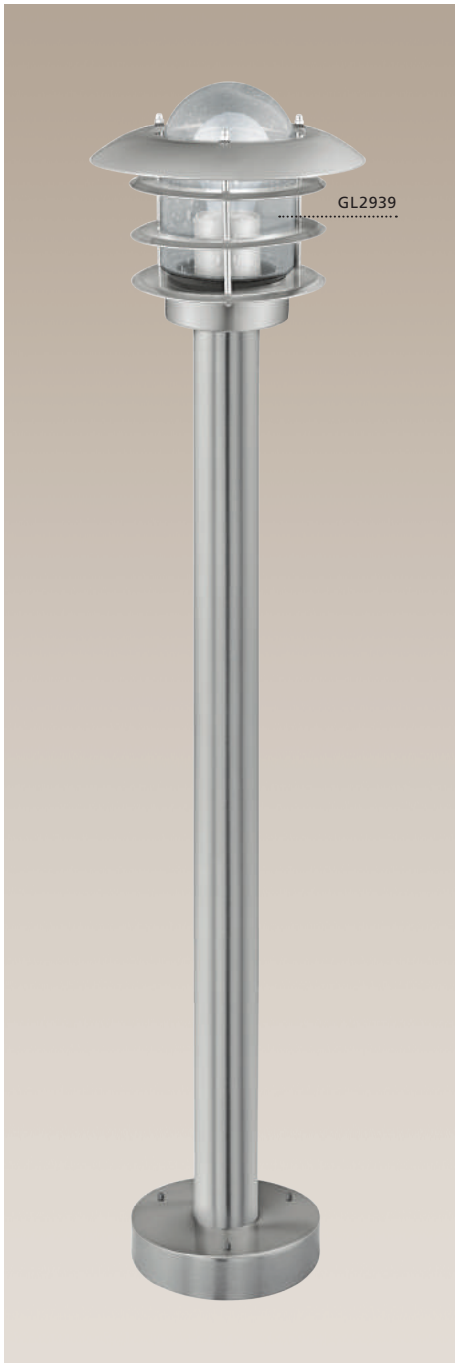

### 30182 MOUNA

наземный светильник; нержавеющая сталь, сталь / стекло с пузырьками, прозрачный

H 400, Ø 205, Base: Ø 150

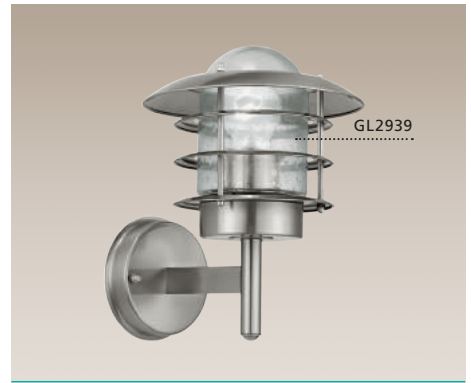

### 30181 MOUNA

настенный светильник; нержавеющая сталь, сталь / стекло с пузырьками, прозрачный

H 260, Ø 205, A 240

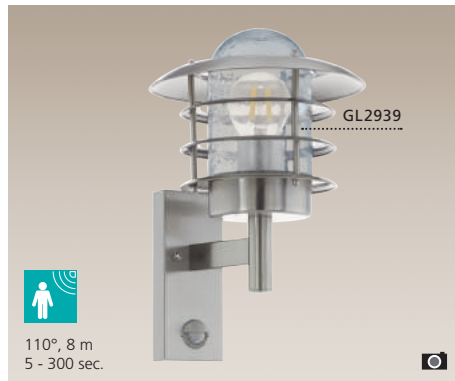
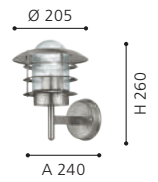
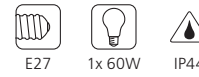

### 96402 MOUNA

настенный светильник; нержавеющая сталь, сталь / стекло с пузырьками, прозрачный

H 265, Ø 220, A 240

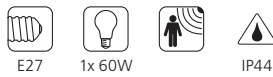

### 83588 MILTON

настенный светильник; нержавеющая сталь, сталь / стекло, прозрачный

B 240, H 310, A 300

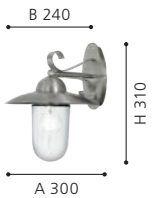
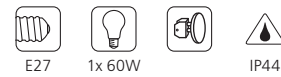

### 30183 MOUNA

наземный светильник; нержавеющая сталь, сталь / стекло с пузырьками, прозрачный

H 950, Ø 205, Base: Ø 150

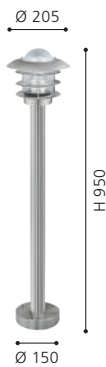







### 89535 MINORCA

наземный светильник; гальванизированная сталь, медная покраска / опаловое стекло, глянецовый белый

H 385, Ø 137, Base: Ø 100



### 89533 MINORCA

настенный светильник; гальванизированная сталь, медная покраска / опаловое стекло, глянецовый белый

B 137, H 365, A 185

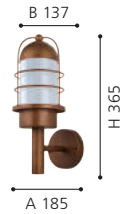
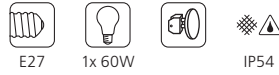

### 89536 MINORCA

наземный светильник; гальванизированная сталь, медная покраска / опаловое стекло, глянецовый белый

H 785, Ø 137, Base: Ø 100





### 83589 MILTON

настенный светильник; гальванизированная сталь, коричневый состаренный / стекло, прозрачный

B 240, H 310, A 300

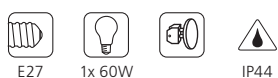

### 94807 NABILA 1

настенный светильник; гальванизированная сталь, коричневый состаренный / стекло, прозрачный

L 110, H 385, A 155



### 90184 SAN TELMO

настенный светильник; гальванизированная сталь, литой алюминий, коричневый состаренный / стекло с пузырьками, прозрачный

L 180, H 350, A 240

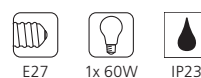



### 93456 NAVEDO

настенный светильник; литой алюминий, черный, серебряный состаренный / стекло, прозрачный

L 200, H 475, A 285



### 93457 NAVEDO

настенный светильник; литой алюминий, черный, серебряный состаренный /стекло, прозрачный

L 200, H 475, A 285



### 93458 NAVEDO

настенный светильник; литой алюминий, черный, серебряный состаренный /стекло, прозрачный

L 200, H 425, A 285

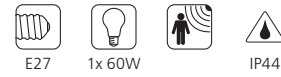

### 93459 NAVEDO

настенный светильник; литой алюминий, черный, серебряный состаренный /стекло, прозрачный

L 290, H 430, A 130



### 93462 NAVEDO

наземный светильник; литой алюминий, черный, серебряный состаренный /стекло, прозрачный

H 470, Ø 230, Base: Ø 170



### 93455 NAVEDO

подвесной светильник; литой алюминий, черный, серебряный состаренный / стекло, прозрачный

H 1045, Ø 230





### 5389 LATERNA 7

настенно-потолочный светильник; литой алюминий, черный /  
стекло матовое, белый

Ø 230, A 140



E27



1x 60W



IP44



Ø 230



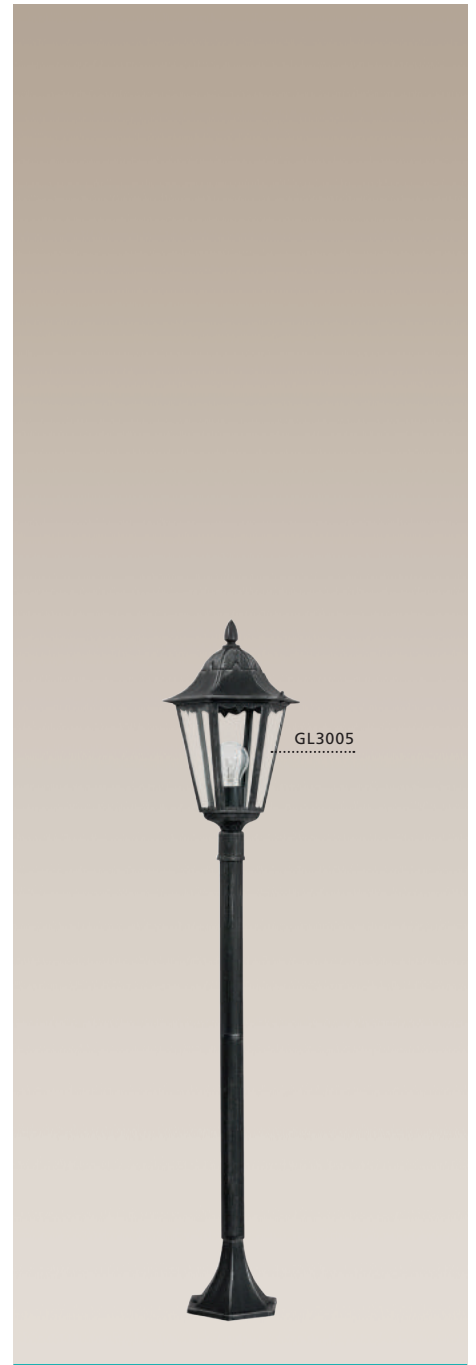

### 93465 NAVEDO

фонарь; литой алюминий, черный, серебряный состаренный / стекло, прозрачный

### 93464 NAVEDO

фонарь; литой алюминий, черный, серебряный состаренный /стекло, прозрачный

### 93463 NAVEDO

наземный светильник; литой алюминий, черный, серебряный состаренный /стекло, прозрачный

H 2200, Ø 560, Base: Ø 230

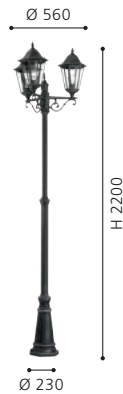

9 002759 934651



H 2000, Ø 230, Base: Ø 245



9 002759 934644



H 1200, Ø 230, Base: Ø 170



9 002759 934637





### 93454 NAVEDO

фонарь; литье алюминий, белый /  
стекло, прозрачный

H 2200, Ø 560, Base: Ø 230



E27



3x 60W



IP44

Ø 560



H 2200

Ø 230



9 002759 934545



### 93453 NAVEDO

фонарь; литье алюминий, белый /  
стекло, прозрачный

H 2000, Ø 230, Base: Ø 245



E27



1x 60W



IP44

Ø 230



H 2000

Ø 245



9 002759 934538

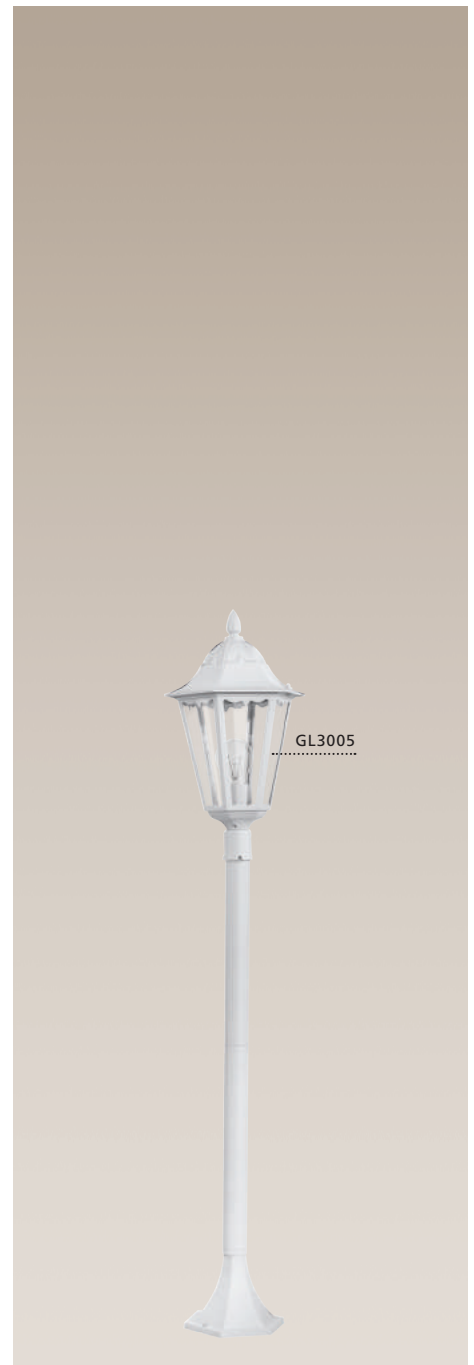

### 93452 NAVEDO

наземный светильник; литье алюминий, белый /  
стекло, прозрачный

H 1200, Ø 230, Base: Ø 170



E27



1x 60W



IP44

Ø 230



H 1200

Ø 170



9 002759 934521





### 93445 NAVEDO

настенный светильник; литье алюминий, белый /  
стекло, прозрачный

L 200, H 475, A 285



### 93446 NAVEDO

настенный светильник; литье алюминий, белый /  
стекло, прозрачный

L 200, H 475, A 285



### 93447 NAVEDO

настенный светильник; литье алюминий, белый /  
стекло, прозрачный

L 200, H 425, A 285

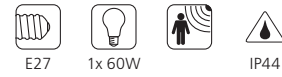

### 93448 NAVEDO

настенный светильник; литье алюминий, белый /  
стекло, прозрачный

L 290, H 430, A 130



### 93451 NAVEDO

наземный светильник; литье алюминий, белый /  
стекло, прозрачный

H 470, Ø 230, Base: Ø 170



### 93444 NAVEDO

подвесной светильник; литье алюминий, белый /  
стекло, прозрачный

H 1045, Ø 230









### 22996 LATERNA 5

фонарь; литой алюминий, белый / стекло, прозрачный

H 1920, Ø 550, Base: Ø 260

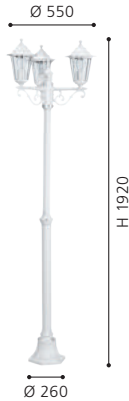

9 002759 229962



### 22995 LATERNA 5

наземный светильник; литой алюминий, белый / стекло, прозрачный

H 1000, Ø 205, Base: Ø 170

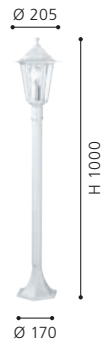

9 002759 229955



### 22465 LATERNA 5

подвесной светильник; литой алюминий, белый / стекло, прозрачный

H 900, Ø 205

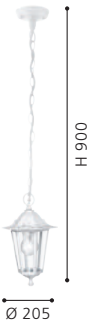

9 002759 224653



### 22466 LATERNA 5

наземный светильник; литой алюминий, белый / стекло, прозрачный

H 405, Ø 205, Base: Ø 170



9 002759 224660





### 22463 LATERNA 5

настенный светильник; литой алюминий, белый / стекло, прозрачный

L 165, H 350, A 215



E27



1x 60W



IP44



9 002759 224639



### 22462 LATERNA 5

настенный светильник; литой алюминий, белый / стекло, прозрачный

L 165, H 350, A 215



E27



1x 60W



IP44



9 002759 224622



### 22464 LATERNA 5

настенный светильник; литой алюминий, белый / стекло, прозрачный

L 165, H 425, A 235



E27



1x 60W



IP44



9 002759 224646





### 22145 LATERNA 4

фонарь; литой алюминий, черный / стекло, прозрачный

H 1920, Ø 550, Base: Ø 260



9 002759 221454



### 22144 LATERNA 4

наземный светильник; литой алюминий, черный / стекло, прозрачный

H 1000, Ø 205, Base: Ø 170



9 002759 221447



### 22471 LATERNA 4

подвесной светильник; литой алюминий, черный / стекло, прозрачный

H 900, Ø 205



9 002759 224714



### 22472 LATERNA 4

наземный светильник; литой алюминий, черный / стекло, прозрачный

L 205, B 165, H 405, Base: Ø 170



9 002759 224721





### 22467 LATERNA 4

настенный светильник; литой алюминий, черный / стекло, прозрачный

L 165, H 350, A 215



E27



1x 60W



IP44



9 002759 224677



### 22468 LATERNA 4

настенный светильник; литой алюминий, черный / стекло, прозрачный

L 165, H 350, A 215



E27



1x 60W



IP44



9 002759 224684



### 22469 LATERNA 4

настенный светильник; литой алюминий, черный / стекло, прозрачный

L 165, H 425, A 235



E27



1x 60W



IP44



9 002759 224691





### 4171 OUTDOOR CLASSIC

Фонарь; литой алюминий, черно-зеленый /  
стекло, прозрачный

H 2130, Ø 530, Base: Ø 250



E27



3x 60W



IP23

Ø 530



H 2130

Ø 250



9 002759 417109





### 4172 OUTDOOR CLASSIC

наземный светильник; литой алюминий, черно-зеленый / стекло, прозрачный

H 1200, Ø 190, Base: Ø 150



### 4174 OUTDOOR CLASSIC

настенный светильник; литой алюминий, черно-зеленый / стекло, прозрачный

B 190, H 530, A 260



### 4175 OUTDOOR CLASSIC

настенный светильник; литой алюминий, черно-зеленый / стекло, прозрачный

B 190, H 480, A 260

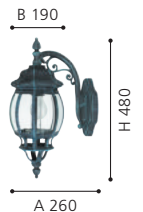
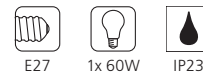

### 4173 OUTDOOR CLASSIC

наземный светильник; литой алюминий, черно-зеленый / стекло, прозрачный

H 600, Ø 190, Base: Ø 150





*Spots, Einbauleuchten & Zubehör*

Встраиваемые светильники, споты & аксессуары



# Обзор

 <b>NEMA 1</b> стр. 120	 <b>NEMA 1</b> стр. 120	 <b>RIGA 1</b> стр. 120	 <b>NEMA</b> стр. 120	 <b>FAEDO 2</b> стр. 121	 <b>FAEDO 1</b> стр. 122	 <b>ZIMBA</b> стр. 124	 <b>ZIMBA</b> стр. 124
 <b>ZIMBA-LED</b> стр. 124	 <b>ZIMBA-LED</b> стр. 124	 <b>RIGA 3</b> стр. 126	 <b>LAMEDO</b> стр. 126	 <b>LAMEDO</b> стр. 126	 <b>MARGO</b> стр. 126	 <b>PINEDA-IP</b> стр. 127	 <b>DETECT ME 1</b> стр. 128
 <b>DETECT ME 1</b> стр. 128	 <b>DETECT ME 2</b> стр. 128	 <b>DETECT ME 3</b> стр. 128	 <b>DETECT ME 4</b> стр. 129	 <b>PARK 4</b> стр. 130	 <b>CONNECTOR BOX</b> стр. 130	 <b>CONNECTOR BOX</b> стр. 130	 <b>PARK 4</b> стр. 130
 <b>PARK T</b> стр. 130	 <b>CUBA</b> стр. 131	 стр. 131					



### 94109 RIGA 1

спот; нержавеющая сталь, сталь

В 140, Н 630

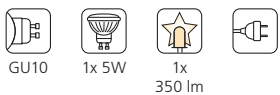

9 002759 941093

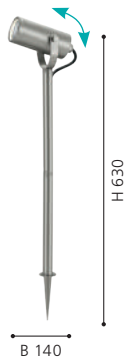

### 93384 NEMA 1

спот; пластик, черный / пластик

L 115, В 60, Н 185



9 002759 933845



### 93385 NEMA 1

спот; пластик, черный / пластик

L 115, В 115, Н 180



9 002759 933852

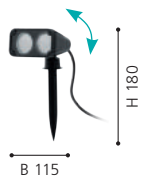

### 94111 NEMA

спот; нержавеющая сталь, сталь

L 110, В 85, Н 240, ET 165



9 002759 941116





- GL2640      ● GL2642
- GL2641      ● GL2643

**94111**

Спот NEMA дополнительно укомплектован 3 сменными светофильтрами разных цветов: красный, зеленый, синий



**96284 FAEDO 2**

спот; алюминий, черный / стекло, прозрачный

L 130, B 50, H 405

- LED
- 10W
- 900 lm
- 
- 
- IP44

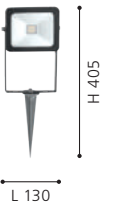

**96285 FAEDO 2**

спот; алюминий, серебряный / стекло, прозрачный

L 130, B 50, H 405

- LED
- 10W
- 900 lm
- 
- 
- IP44

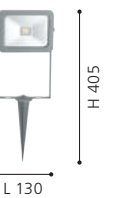



### 95403 FAEDO 1

настенный светильник; алюминий, серебряный / стекло, прозрачный

L 130, H 105, A 50



### 95404 FAEDO 1

настенный светильник; алюминий, серебряный / стекло, прозрачный

L 160, H 140, A 50

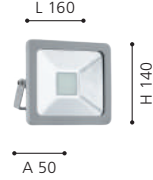
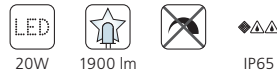

### 95405 FAEDO 1

настенный светильник; алюминий, серебряный / стекло, прозрачный

L 205, H 155, A 50

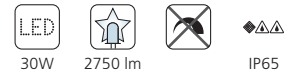

### 95407 FAEDO 1

настенный светильник; алюминий, серебряный / стекло, прозрачный



100°, 6 m  
6 - 270 sec.

L 130, H 190, A 50

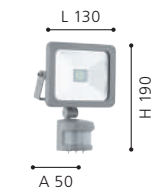

### 95408 FAEDO 1

настенный светильник; алюминий, серебряный / стекло, прозрачный



100°, 6 m  
6 - 270 sec.

L 160, H 220, A 50



### 95409 FAEDO 1

настенный светильник; алюминий, серебряный / стекло, прозрачный



100°, 6 m  
6 - 270 sec.

L 205, H 235, A 50





### 95406 FAEDO 1

настенный светильник; алюминий, серебряный /  
стекло, прозрачный

L 245, H 175, A 50



50W



4450 lm



IP65



9 002759 954062



### 95411 FAEDO 1

настенный светильник; алюминий, серебряный /  
стекло, прозрачный

L 245, H 250, A 50



50W



4450 lm



IP44



9 002759 954116

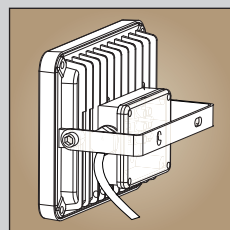

### FAEDO 1

Пржектор оснащен усиленным  
креплением корпуса

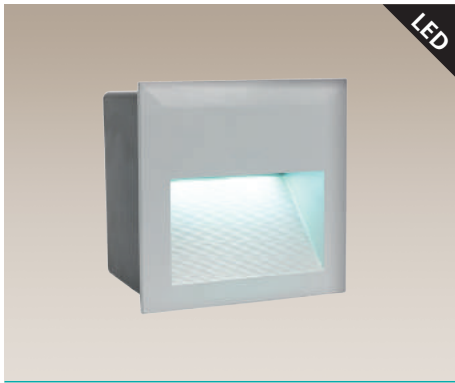

### 95235 ZIMBA-LED

встраиваемый светильник; литой алюминий, серебряный

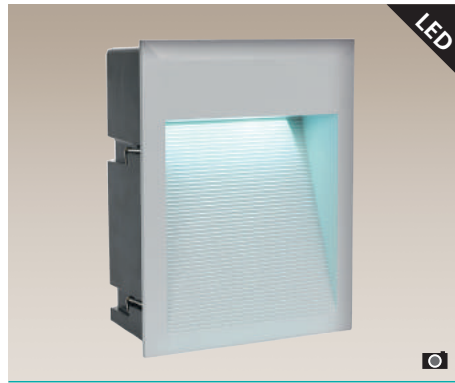

### 95234 ZIMBA-LED

встраиваемый светильник; литой алюминий, серебряный



### 95233 ZIMBA-LED

встраиваемый светильник; литой алюминий, серебряный

L 140, B 140, H 5, ET 95

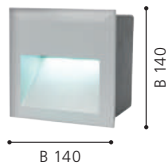

L 235, B 185, H 5, ET 95



H 5, Ø 125, ET 95



### 88008 ZIMBA

встраиваемый светильник; литой алюминий, серебряный



### 88575 ZIMBA

встраиваемый светильник; литой алюминий, серебряный / стекло матовое, белый

L 243, B 101, H 5, ET 100

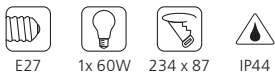

L 227, B 127, H 13, ET 75

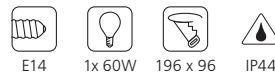





### 93481 LAMEDO

встраиваемый светильник; нержавеющая сталь, сталь / стекло матовое, белый



### 93482 LAMEDO

встраиваемый светильник; нержавеющая сталь, сталь / стекло матовое, белый

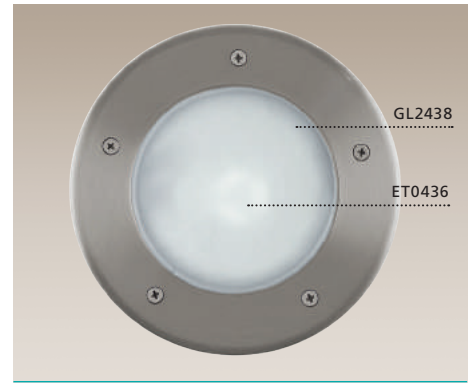

### 86189 RIGA 3

встраиваемый светильник; нержавеющая сталь, сталь / пластик, белый

L 100, B 100, ET 65



1x 2,5W  
1x  
180 lm  
Ø 95



IP67



9 002759 934811

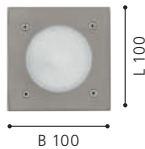

Ø 100, ET 65



1x 2,5W  
1x  
180 lm  
Ø 95



IP67



9 002759 934828



H 285, Ø 170



E27  
1x 15W  
IP67



IP67



9 002759 861896



## ЛАНДШАФТНЫЕ ВСТРАИВАЕМЫЕ СВЕТИЛЬНИКИ



### LAMEDO & RIGA 3

Благодаря соединительным коробкам CONNECTOR BOX можно забыть про хаотично расположенные электрокабели на вашей даче.



## ВСТРАИВАЕМЫЕ СВЕТИЛЬНИКИ



### PINEDA IP & MARGO

IP65 / IP44

Светильники с IP65/44 фронтальной стороны и IP20 внутренней стороны.

IP20



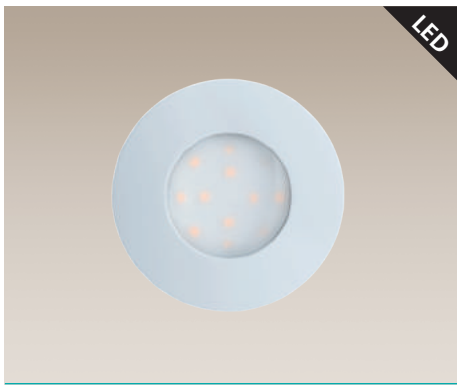

### 96414 PINEDA-IP

встраиваемый светильник; пластик, белый

Ø 78, ET 35

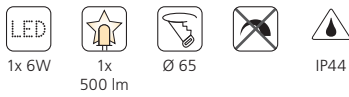

Ø 78



### 96415 PINEDA-IP

встраиваемый светильник; пластик, никель матовый

Ø 78, ET 35

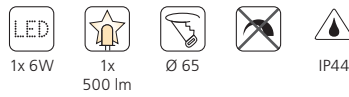

Ø 78

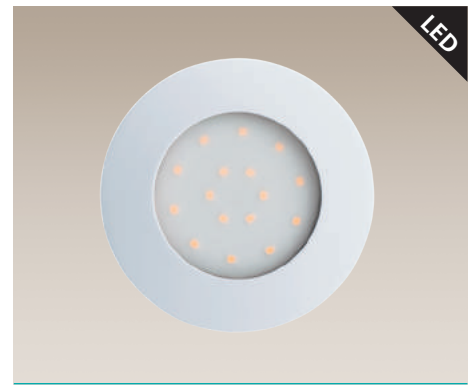

### 96416 PINEDA-IP

встраиваемый светильник; пластик, белый

Ø 102, ET 35

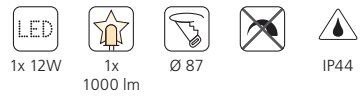

Ø 102



### 94092 MARGO

встраиваемый светильник; литой алюминий, сталь / стекло матовое, белый

H 10, Ø 84, ET 125

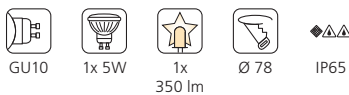

Ø 84



### 94093 MARGO

встраиваемый светильник; литой алюминий, белый / стекло матовое, белый

H 10, Ø 84, ET 125



Ø 84



### 96417 PINEDA-IP

встраиваемый светильник; пластик, никель матовый

Ø 102, ET 35



Ø 102



180°, 12 m  
10 - 900 sec.

**96452 DETECT ME 1**

аксессуар; пластик, белый

L 55, H 70, A 80



180°, 12 m  
10 - 900 sec.

**96455 DETECT ME 2**

аксессуар; пластик, белый

L 80, H 50, A 115

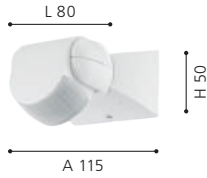

180°, 12 m  
10 - 420 sec.

**96457 DETECT ME 3**

аксессуар; пластик, белый

L 75, H 120, A 70



180°, 12 m  
10 - 900 sec.

**96454 DETECT ME 1**

аксессуар; пластик, черный

L 55, H 70, A 80

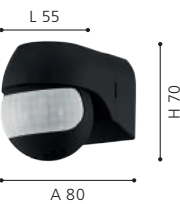

180°, 12 m  
10 - 900 sec.

**96456 DETECT ME 2**

аксессуар; пластик, черный

L 80, H 50, A 115

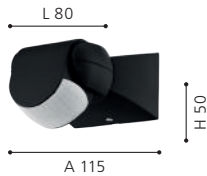

180°, 12 m  
10 - 420 sec.

**96458 DETECT ME 3**

аксессуар; пластик, серебряный

L 75, H 120, A 70





2000 lux



360°, 12 m  
10 - 900 sec.

### 96459 DETECT ME 4

аксессуар; пластик, белый

L 60, H 80, A 120



IP44



2000 lux



360°, 12 m  
10 - 900 sec.

### 96462 DETECT ME 4

аксессуар; пластик, черный

L 60, H 80, A 120



IP44



DETECT ME 1



DETECT ME 2



DETECT ME 3



DETECT ME 4



Аксессуары в комплекте



	DETECT ME 1	DETECT ME 2	DETECT ME 3	DETECT ME 4
				•
	•	•	•	•
			•	•
				•
Аксессуары в комплекте				
				входят в комплект, см. стр 139
	10 сек. - 15 мин.	10 сек. - 15 мин.	10 сек. - 7 мин.	10 сек - 15 мин.
	12 метров	12 метров	12 метров	12 метров
	180°	180°	180°	360°
	+/- 40° по горизонтали 45° по вертикали	+/- 30° по горизонтали +/- 90° по вертикали		
	3 - 2000lx	3 - 2000lx	3 - 2000lx	3 - 2000lx
	макс. 800W лампа накаливания макс. 400W флуоресцентная лампа	макс. 1200W лампа накаливания макс. 300W флуоресцентная лампа	макс. 1200W лампа накаливания макс. 300W флуоресцентная лампа	макс. 1200W лампа накаливания макс. 300W флуоресцентная лампа

Идеальная высота для монтажа - 2 м



### 90748 PARK 4

аксессуар; нержавеющая сталь / пластик, зеленый

L 115, B 115, H 400, Base: B 160, T 160



IP44



9 002759 907488

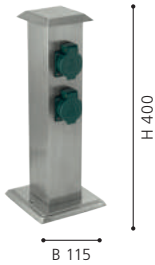

### 93426 PARK 4

аксессуар; сталь, пластик, черный

L 115, B 115, H 400, Base: B 160, T 160



IP44



9 002759 934262



### 91206 CONNECTOR BOX

аксессуар; пластик, черный

H 50, Ø 155



IP68



9 002759 912062

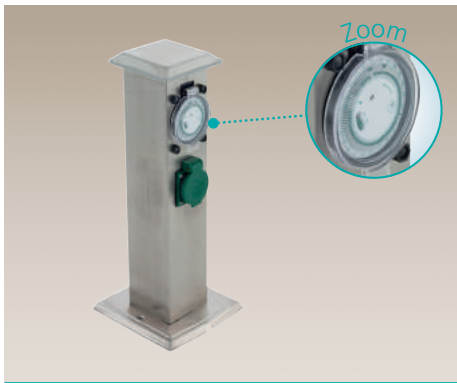
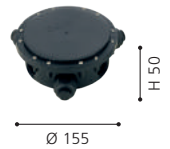

### 96351 PARK T

аксессуар; нержавеющая сталь / пластик, зеленый

L 115, B 115, H 400, Base: B 160, T 160



IP44



9 002759 963514

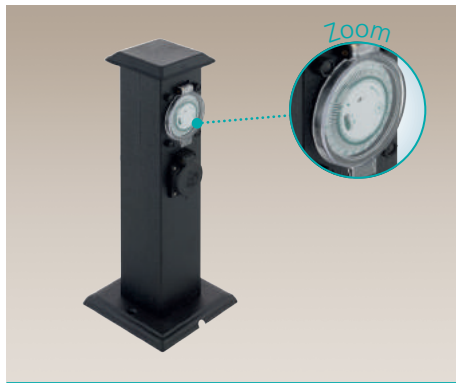

### 96352 PARK T

аксессуар; сталь, пластик, черный

L 115, B 115, H 400, Base: B 160, T 160



IP44



9 002759 963521



### 91207 CONNECTOR BOX

аксессуар; пластик, черный

H 50, Ø 155



IP68



9 002759 912079

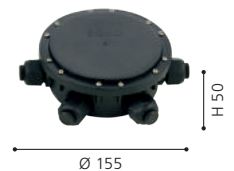



**88744**

Кольшек для крепления уличных светильников CUBA дает возможность установки светильников как в грунт, так и в бетонное покрытие.

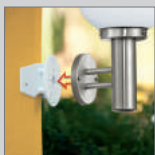

**88152, 88153, 94112**

Знак пиктограммы выше обозначает модели светильников с возможностью простого углового крепления с использованием этих аксессуаров.

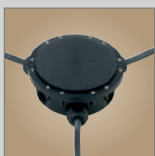

Благодаря соединительным коробкам CONNECTOR BOX можно забыть про хаотично расположенные электрокабели на вашей даче.

**91206:** 2 соединения (1 вход; 2 выход)

**91207:** 5 соединений (1 вход; 5 выход)



**96352, 96351**

Блок штекерных розеток „PARK T“ оснащен таймером.

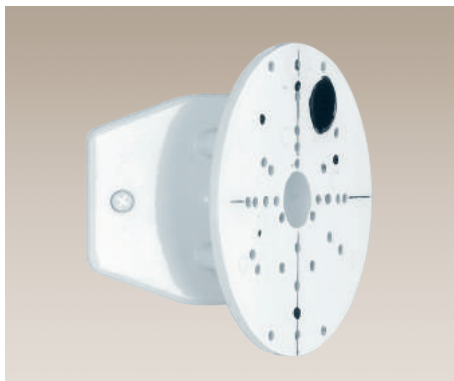

**88152**

аксессуар; сталь, белый

Ø 112



9 002759 881528



Ø 112

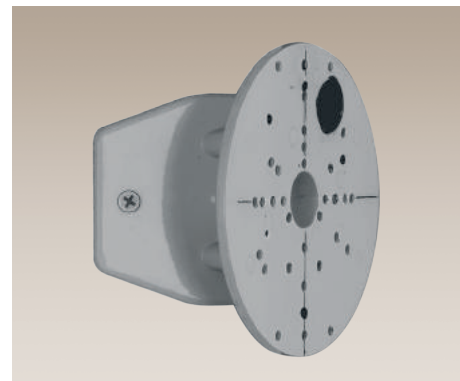

**94112**

аксессуар; сталь, серебряный

Ø 112



9 002759 941123



Ø 112



**88744 CUBA**

аксессуар; сталь, оцинкованная сталь

H 300, Ø 185



8x



9 002759 887445



Ø 185

H 300

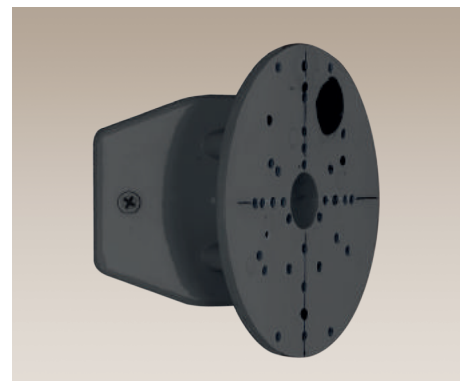

**88153**

аксессуар; сталь, черный

Ø 112



9 002759 881535

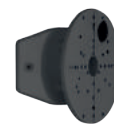

Ø 112

A modern garden lantern with a black metal cage and a glowing white globe, set in a garden with a stone pillar and a planter.

*Светильники для сада*



**LORENA**  
стр. 134



**LORENA 1**  
стр. 134



**TERRICO**  
стр. 136



**TERRICO**  
стр. 136



**TERRICO**  
стр. 136



**FERROTERRA**  
стр. 137



**TERRENO**  
стр. 137



### 89326 LORENA 1

наземный светильник; гальванизированная сталь, коричневый состаренный / стекло, шампань

H 580, Ø 215, Base: Ø 180

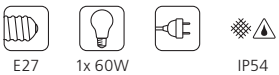

E27 1x 60W IP54



9 002759 893262



### 89173 LORENA

наземный светильник; гальванизированная сталь, коричневый состаренный / опаловое стекло, белый

H 1130, Ø 600, Base: Ø 250

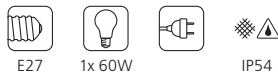

E27 1x 60W IP54



9 002759 891732









### 94335 TERRICO

наземный светильник; гальванизированная сталь, черный / стекло матовое, белый

### 94333 TERRICO

наземный светильник; гальванизированная сталь, черный / стекло матовое, белый

### 94332 TERRICO

наземный светильник; гальванизированная сталь, коричневый / стекло матовое, белый

H 310, Ø 315, Base: Ø 230

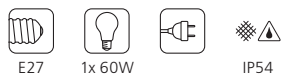

H 580, Ø 305, Base: Ø 230

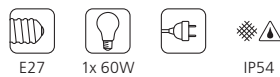

H 750, Ø 230, Base: Ø 230

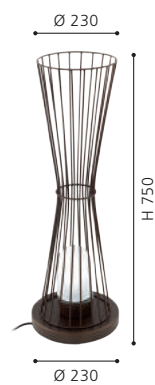
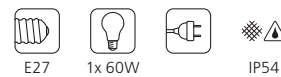



### 89565 FERROTERRA

напольный светильник; гальваническая сталь, черный, серебряный состаренный / опаловое стекло, белый

H 450, Ø 452, Base: Ø 195



E27



1x 60W



IP54

AS LONG  
AS STOCK  
LASTS!



9 002759 895655

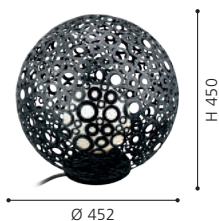

### 91436 TERRENO

наземный светильник; гальванизированная сталь, черный, серебряный состаренный / опаловое стекло, белый

H 900, Ø 380



E27



1x 60W



IP54



9 002759 914363



# Условные обозначения

## ДАТЧИК ДВИЖЕНИЯ

Этим значком обозначаются светильники с датчиком движения. Дополнительно указываются угол работы, дальность и продолжительность работы датчика.

## АРТИКУЛ

## ОПИСАНИЕ

Описание продукции составлено следующим образом: тип светильника; материал корпуса, цвет корпуса/материал абажура или плафона, цвет абажура или плафона

## РАЗМЕРЫ

Все размеры в mm

L = длина |  
B = ширина |  
H = высота |  
∅ = диаметр |  
A = отступ |  
ET = глубина монтажа |  
Base = размер основания

Внимание! Указанные размеры относятся исключительно к светильнику. Отступы необходимые для безопасной эксплуатации светильника не учитываются.

## ПИКТОГРАММЫ

Технические характеристики представлены в виде пиктограмм. Обзор всех пиктограмм на следующих страницах.

90°, 7 m  
1,0 - 240 sec.

**30192 CERNO**  
настенный светильник; нержавеющая сталь, сталь / стекло матовое, белый

L 140, H 190, A 110

E27 1x 40W IP44

9 002759 301927

A++-E

L 140  
H 190  
A 110

## ЗАПАСНЫЕ ЧАСТИ

В случае наличия запасных частей к продукту, их артикулы приведены на фотографии.

## КАМЕРА

Значок камеры указывает на наличие у данного артикула фотографии в интерьере.

## НАЗВАНИЕ СЕРИИ

## ЭСКИЗЫ

Размеры эскиза указывают наибольшую величину светильника. Возможность регулировки продукта показывается бирюзовой стрелкой.

## ЗНАКИ

Цвет LED |



EEI без ламп |



EEI лампы в комплекте |



EEI описание |

Индекс цветопередачи



## ВЫКЛЮЧАТЕЛЬ



встроенный диммер



перекидной выключатель



шнуровой выключатель



ножной выключатель



ножной диммер



кнопочный выключатель



кабельный выключатель



датчик движения



датчик освещения день/ночь



пульт управления



Светильник включается, выключается и диммируется путем прикосновения к специальной части светильника "Touch me".



С помощью обычного выключателя можно менять атмосферу освещения. Быстро нажатие выключателя меняет освещение (см. изображение ниже). Медленное нажатие действует в обычном режиме включения/выключения освещения.



1x

2x

3x

4x

## КЛАСС ЗАЩИТЫ

Класс защиты показывает степень защищенности продукции от электрического удара. Все светильники в этом каталоге имеют как минимум КЛАСС ЗАЩИТЫ 1. Если класс защиты выше, то он указывается отдельным символом в информационном окошке светильника.



класс защиты 1:  
защитное заземление



класс защиты 2:  
защитная изоляция



класс защиты 3:  
защита от низкого напряжения

## СТЕПЕНЬ ЗАЩИТЫ

Степень защиты обеспечивает безопасное использование светильника. Первая цифра степени защиты IP показывает защищенность от проникновения посторонних предметов, вторая цифра отражает уровень влагозащищенности. Все светильники в данном каталоге имеют как минимум степень защиты IP20. Если степень защиты выше, то она указывается отдельным символом в информационном окошке светильника.



IP33



IP44



IP54



IP65



IP67; IP68

## ЦВЕТ И СВЕТОВОЙ ПОТОК

Цвета светодиодов приводятся в пиктограммах (см. ниже), а их световой поток непосредственно под ними. Световой поток измеряется в люменах, и указывает количество света, исходящее от светодиода. Чем выше этот показатель, тем ярче свет светильника.



теплый белый



нейтральный белый



холодный белый



разноцветный



голубой



регулируемый белый

## ДОПОЛНИТЕЛЬНЫЕ ПИКТОГРАММЫ



сменный LED



диммируемый



не диммируемый



возможность углового крепления



кабель и штеккер в комплекте



максимально допустимая нагрузка



размер вреза (в мм)





















упаковочная/транспортная единица

# Условные обозначения



## ЦОКОЛИ

 2GX13	 E14	 E27	 G4	 G5
 G9	 GU5,3	 GU10	 GX53	 R7S
 LED				



## СВЕТОДИОДНЫЕ ЛАМПЫ

 E14 C35 LED E14	 E14 C35 FILA E14	 E14 C35 TIP LED E14	 E14 C35 TIP FILA E14	 E14 G45 LED E14
 E14 G45 FILA E27	 E14 R50 LED E14	 E27 G45 LED E27	 E27 G45 FILA E27	 E27 G90 LED E27
 E27 G95 FILA E27	 E27 A60 LED E27	 E27 A60 FILA E27	 E27 R63 LED E27	 G4 LED G4
 G9 LED G9	 MR16 LED GU5,3	 GU10 LED GU10	 GX53 LED GX53	





## ФЛУОРЕСЦЕНТНЫЕ ЛАМПЫ

 E27 G100 CFL E27	 T5 TUBE G5	 T5 RING 2GX13
---	--	---

## ГАЛОГЕННЫЕ ЛАМПЫ

 E14 C35 ECO E14	 E14 G45 ECO E14	 E27 A55 ECO E27	 E27 R63 ECO E27	 G4 G4
 G9 G9	 MR16 GU5,3	 GU10 GU10	 GY6,35 GY6,35	 R7S R7S

## ЛАМПЫ НАКАЛИВАНИЯ

 E14 C35 E14	 E14 C35 TIP E14	 E14 G45 E14	 E27 A60 E27	 E14 R50 E14
--	---	---	---	---

# Заметки

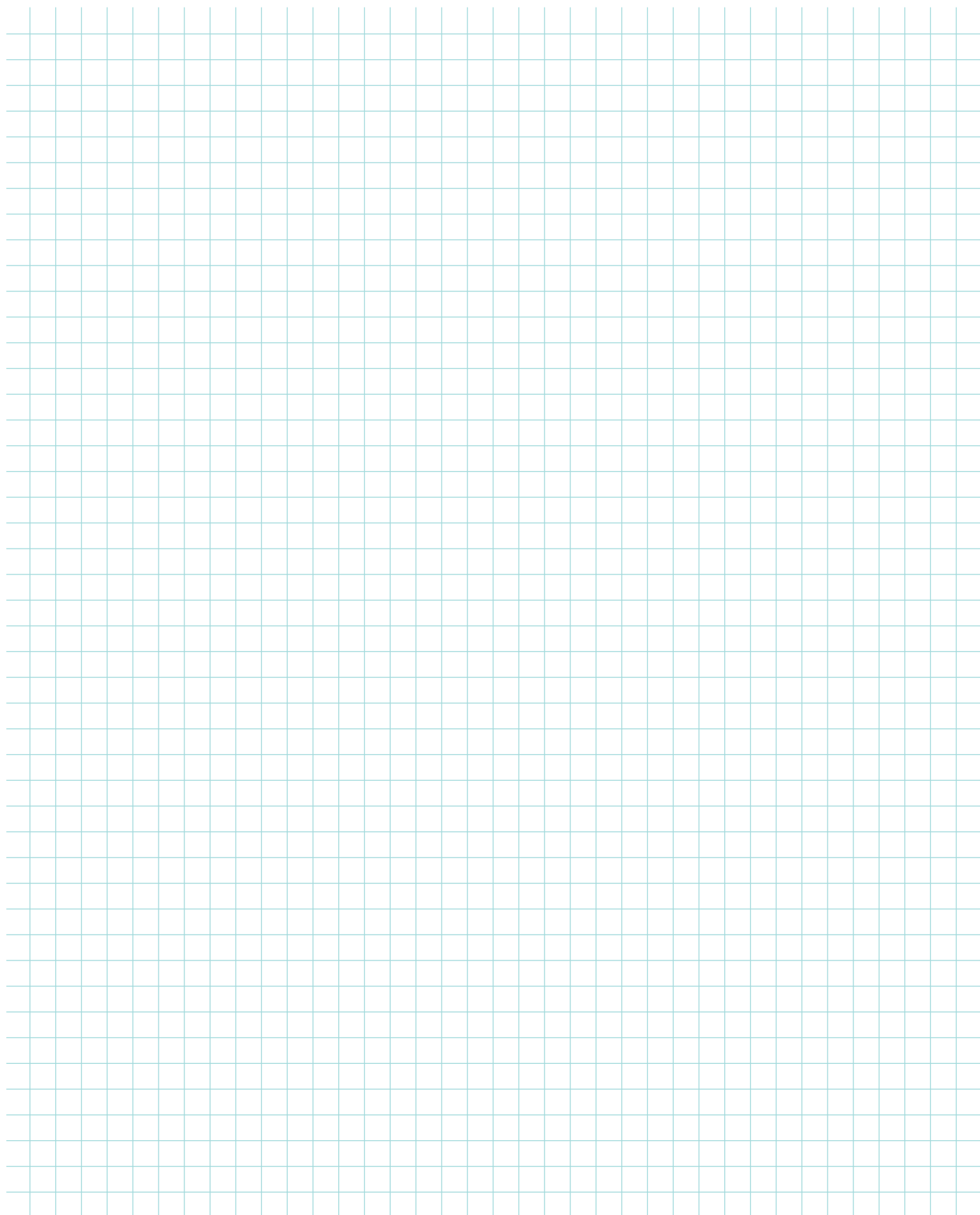

# Оглавление

НАЗВАНИЕ СЕРИИ	СТР.	НАЗВАНИЕ СЕРИИ	СТР.	НАЗВАНИЕ СЕРИИ	СТР.	НАЗВАНИЕ СЕРИИ	СТР.
ACATE	47	FAEDO 2	121	ONJA	62	TERRENO	137
AGOLADA	20	FAEDO 2	121	ONTANEDA	60	TERRICO	136
ALAMONTE	72	FERROTERRA	137	OROPOS	43	TOLLERA	88
ALAMONTE 1	74	HELSINKI	26-27	OUTDOOR CLASSIC	116-117	TRABADA	58
ALAMONTE 2	92	HILBURN	78	PARDELA 1	44	TRONO 2	20
ALBACETE	88	HILBURN 1	76	PARK	50	TRONO STICK	20
ALORIA	94-95,98-99	INFESTO	52	PARK 4	130	VALDEO	90
ANOLA	65	INFESTO 1	52	PARK T	130	VENTO 1	60
APIMARE	90	ISOBA	62,92	PENALVA	16	VENTO 2	60
APIMARE	90	JORBA	38	PENALVA 1	16-17	VOLPINO	43
ARCHA	57	JORBA	38	PERAFITA	39	ZAMORANA	46
ARGOLIS	53,60	KIBEA	48	PIAS	44	ZIMBA	124
ASCOLI	25	KONYA	32	PINEDA-IP	127	ZIMBA-LED	124
ATOLLARI	34	LAMEDO	126	POLIENITO	14		
BARROSELA	76,86-87	LATERNA 4	114-115	PREDAZZO	48		
BASALGO 1	18	LATERNA 5	112-113	PULFERO	80		
BEVERLY	32	LATERNA 7	107	PULFERO 1	82		
BOSARO	37	LEPUS	66	RALORA	56		
BREGANZO	50,92	LISIO	100-101	RALORA 1	57		
BREGANZO 1	51	LORENA	134	RAVARINO	32		
CABOS	25	LORENA 1	134	REDONDO	35		
CALGARY	31	LORMES	59	RIGA	24-25		
CALGARY 1	44	MALGERA	50	RIGA 1	119-120		
CERNO	56,138	MAMURRA	90	RIGA 3	126		
CITY	55,66	MARGO	127	RIGA-LED	22-23		
CITY 1	55	MELGOA	86-87	ROBLEDO	33		
CITY LED	54	MILTON	66,102,105	ROFFIA	30		
COLINDRES	87	MINORCA	104	SAN TELMO	105		
COLINDRES 1	86	MINORCA	104	SERVOI	36		
COMIO	42	MONASTERIO	84	SESIMBA	40,92		
COMUNERO	70	MORINO	34	SESIMBA 1	40		
CONNECTOR BOX	130	MOUNA	102	SEVILIA	92		
COVALE	36	NABILA 1	105	SEVILLA	66		
CUBA	131	NADELA	48	SIDNEY	96		
DARIL	56	NAVEDO	106,108-110	SIONES 1	64		
DETECT ME 1	128	NAVEDO	106,108-110	SITIA	45		
DETECT ME 2	128	NEMA	119-120	SOJO	48		
DETECT ME 3	128	NEMA 1	119-120	SONELLA	52		
DETECT ME 4	129	NISIA	28	SONELLA 1	52		
ENTRIMO	66,88	NISIA 1	29	STOCKHOLM 1	25		
FACUNDA	88	OHIO	28	TABO	46		
FAEDO 1	122-123	ONCALA	42	TABO-LED	44		



АТИКУЛ	СТР.	АТИКУЛ	СТР.	АТИКУЛ	СТР.	АТИКУЛ	СТР.	АТИКУЛ	СТР.	АТИКУЛ	СТР.	АТИКУЛ	СТР.
4171	116	86389	31	93367	35	94119	32	94842	78	95991	36	96416	127
4172	117	86541	32	93368	35	94121	60	94843	78	95992	36	96417	127
4173	117	87105	96	93369	44	94125	20	94844	78	96006	39	96452	128
4174	117	88008	124	93384	120	94127	20	94845	47	96007	39	96454	128
4175	117	88119	66	93385	120	94128	20	94848	40	96013	33	96455	128
5389	107	88139	55	93402	98	94133	50	94849	40	96014	33	96456	128
22144	114	88142	55	93403	99	94137	50	94851	46	96015	36	96457	128
22145	114	88144	55	93404	98	94138	50	94852	58	96016	36	96458	128
22462	113	88152	131	93405	98	94184	46	94853	58	96017	51	96459	129
22463	113	88153	131	93406	94	94185	46	94854	82	96018	51	96462	129
22464	113	88487	66	93407	95	94186	46	94855	82	96019	40	96491	60
22465	112	88489	66	93408	94	94212	54	94856	82	96021	40	96492	60
22466	112	88575	124	93409	94	94213	54	94857	82	96022	40	96494	53
22467	115	88744	131	93426	130	94277	18	94858	87	96206	66	96495	53
22468	115	88802	65	93438	48	94278	18	94859	76	96207	88	96504	23
22469	115	88803	65	93444	110	94279	18	94861	86	96222	90	96505	23
22471	114	88807	65	93445	110	94281	18	94862	86	96223	90	96583	59
22472	114	89173	134	93446	110	94332	136	94863	87	96232	90	96584	59
22995	112	89314	28	93447	110	94333	136	94864	78	96233	90		
22996	112	89326	134	93448	110	94335	136	94865	76	96234	88		
27126	28	89366	57	93451	110	94779	37	94866	76	96235	88		
30173	56	89533	104	93452	109	94784	60	94867	76	96236	88		
30181	102	89535	104	93453	109	94785	60	94868	76	96237	43		
30182	102	89536	104	93454	109	94786	72	94871	52	96238	43		
30183	102	89565	137	93455	106	94787	72	94872	52	96239	90		
30184	100	89767	62	93456	106	94788	74	94874	52	96241	90		
30185	101	89768	62	93457	106	94789	74	94876	52	96255	38		
30186	100	89769	62	93458	106	94792	86	94877	52	96256	38		
30187	100	90121	25	93459	106	94793	46	95016	14	96262	88		
30188	100	90184	105	93462	106	94794	46	95017	14	96263	88		
30191	56	90748	130	93463	108	94796	40	95018	14	96267	92		
30192	138	90867	66	93464	108	94797	56	95019	14	96268	92		
30193	55	91206	130	93465	108	94798	56	95073	58	96269	92		
30194	55	91207	130	93481	126	94802	20	95074	58	96271	92		
30205	28	91436	137	93482	126	94803	20	95233	124	96272	92		
30206	28	91769	43	93991	37	94804	20	95234	124	96273	92		
30207	28	92735	22	93993	48	94805	86	95235	124	96276	34		
81751	26	92736	22	93994	48	94807	105	95403	122	96277	34		
81752	26	92737	22	94086	56	94811	16	95404	122	96284	121		
81753	27	92738	22	94087	30	94812	16	95405	122	96285	121		
82309	55	93094	99	94088	30	94813	16	95406	123	96294	70		
83278	27	93095	99	94092	127	94817	16	95407	122	96295	70		
83279	26	93096	98	94093	127	94818	16	95408	122	96296	70		
83281	26	93097	95	94099	24	94819	17	95409	122	96297	70		
83432	50	93098	95	94101	24	94827	72	95411	123	96338	64		
83433	50	93099	94	94102	24	94828	72	95976	84	96339	64		
83588	102	93253	48	94103	24	94829	72	95977	84	96341	64		
83589	105	93254	48	94104	24	94831	74	95978	84	96342	64		
83966	96	93256	48	94105	24	94832	74	95979	84	96351	130		
83969	96	93268	25	94106	25	94833	74	95981	42	96352	130		
83971	96	93271	25	94107	25	94834	80	95982	42	96353	62		
86189	126	93318	34	94109	120	94835	80	95985	42	96354	62		
86248	32	93319	34	94111	120	94836	80	95986	42	96365	60		
86385	32	93364	44	94112	131	94837	87	95987	45	96402	102		
86387	31	93365	44	94114	44	94838	87	95988	45	96414	127		
86388	31	93366	29	94118	30	94841	80	95989	57	96415	127		

Все ранее выпущенные каталоги и прейскуранты недействительны с момента выхода данного каталога. Возможны ошибки, опечатки, изменения моделей, цен продуктов, а также технических модификаций.

Доставка товара осуществляется в соответствии с условиями поставки и оплаты. Наша продукция соответствует европейским стандартам качества EN60598.

Продукция с маркировкой ENEC соответствует стандарту 2006/95/EG. Все товары, имеющие дополнительную информацию о безопасности, например, класс защиты IP, обозначены специальными символами и цифрами. Все права на издание этого каталога принадлежат EGLO Leuchten GmbH. Использование любых текстов и фотографий возможно только с нашего письменного согласия. Иллюстрации этого каталога - материалы 4C печати и могут отличаться от оригинала.

Фотографии товаров и товаров в интерьере этого каталога могут отличаться от их реального внешнего вида. ЭГЛО не несет ответственность за правильность, полноту описания продукта и информацию по продукту.

Дизайн, верстка, набор:  
EGLO Leuchten GmbH, A-6136, г. Пиль, Австрия  
Печать: Alpina Druck GmbH, 6020, Innsbruck  
Иллюстрации: EGLO, fotolia.com, istockphoto.com





**EGLO**  
my light | my style

Россия  
ООО "ЭГЛО Лайтинг"  
117105, г. Москва, Варшавское  
ш., 35, стр. 1  
телефон: +7 495 789 43 11  
e-mail: info-russia@eglo.com



[www.eglo.com](http://www.eglo.com)